

LOREX EDGE

NETWORK READY H.264 HIGH PERFORMANCE DIGITAL VIDEO SURVEILLANCE RECORDER

INSTRUCTION MANUAL

English Version 2.0



Lorex Edge mini LH304 Series



Lorex EDGE LH310 Series



Lorex-Edge+ LH320 Series

MODEL:
LH300 SERIES



www.lorextechnology.com

Thank you for purchasing the LH300 Series Lorex-Edge H.264 Digital Video Surveillance Recorder.

This manual refers to the following models:

Lorex Edge

- LH314 (4-channel)
- LH318 (8-channel)
- LH316 (16-channel)

Lorex EDGE+

- LH324 (4-channel)
- LH328 (8-channel)
- LH326 (16-channel)

Lorex Edge mini

- LH304 (4-channel)

To learn more about this product and to learn about our complete range of accessory products, please visit our website at:

www.lorexttechnology.com



CAUTION

**RISK OF ELECTRIC SHOCK
DO NOT OPEN**



CAUTION: TO REDUCE THE RISK OF ELECTRIC SHOCK DO NOT REMOVE COVER. NO USER SERVICABLE PARTS INSIDE.

REFER SERVICING TO QUALIFIED SERVICE PERSONNEL.



The lightning flash with arrowhead symbol, within an equilateral triangle, is intended to alert the user to the presence of uninsulated "dangerous voltage" within the products' enclosure that may be of sufficient magnitude to constitute a risk of electric shock



The exclamation point within an equilateral triangle is intended to alert the user to the presence of important operating and maintenance (servicing) instructions in the literature accompanying the appliance.

WARNING: TO PREVENT FIRE OR SHOCK HAZARD, DO NOT EXPOSE THIS UNIT TO RAIN OR MOISTURE.

CAUTION: TO PREVENT ELECTRIC SHOCK, MATCH WIDE BLADE OF THE PLUG TO THE WIDE SLOT AND FULLY INSERT.

NEED HELP?



CONTACT US FIRST

DO NOT RETURN THIS PRODUCT TO THE STORE

Please make sure to register your product at www.lorextechnology.com to receive product updates and information

3 EASY WAYS TO CONTACT US:

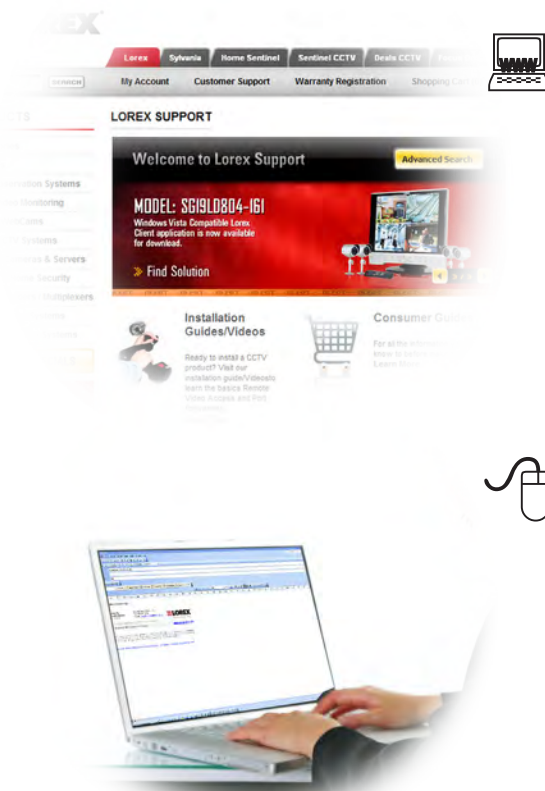

Online:

Product Support is available 24/7 including product information, user manuals, quick start up guides and FAQ's at www.lorextechnology.com/support

To order accessories, visit www.lorextechnology.com



By Email:

Technical Support (for technical/installation issues)
support@lorexcorp.com

Customer Care (for warranty and accessory sales)
customerservice@lorexcorp.com

Customer Feedback
info@lorexcorp.com



By Phone:

NORTH AMERICA:

CUSTOMER SERVICE: 1-888-425-6739 (1-888-42-LOREX)

TECH SUPPORT: 1-877-755-6739 (1-877-75-LOREX)

MEXICO: 1-866-427-6739

INTERNATIONAL: +800-425-6739-0

(Example: From the UK, dial 00 instead of +)





NECESITA AYUDA

COMUNÍQUESE PRIMERO CON NOSOTROS



VOUS AVEZ BESOIN D'AIDE?

CONTACTEZ-NOUS D'ABORD

NO DEVUELVA ESTE PRODUCTO A LA TIENDA

NE RETOURNEZ PAS CE PRODUIT AU MAGASIN

Cerciórese de por favor colocar su producto en www.lorexcctv.com/registration para recibir actualizaciones y la información del producto

Veillez veiller à enregistrer votre produit à www.lorexcctv.com/registration pour recevoir des mises à jour et l'information de produit

3 MANERAS SENCILLAS DE COMUNICARSE CON NOSOTROS:



En línea:

apoyo al producto disponible 24/7 incluyendo información del producto, manuales para el usuario, guías de inicio rápido y preguntas más frecuentes en

www.lorextechnology.com/support

Para colocar pedidos de accesorios, visite

www.lorextechnology.com



Por Correo Electrónico:

soporte técnico (para asuntos técnicos/la instalación)

support@lorexcorp.com

0

servicio al cliente (respecto a la garantía y a la venta de accesorios)

customerservice@lorexcorp.com

Comentarios de cliente

info@lorexcorp.com



Por Teléfono:

L'AMÉRIQUE DU NORD:

ATENCIÓN AL CLIENTE: 1-888-425-6739 (1-888-42-LOREX)

SOPORTE TÉCNICO: 1-877-755-6739 (1-877-75-LOREX)

MEXICO: 1-866-427-6739

INTERNACIONAL: +800-425-6739-0

(Ejemplo: Desde el Reino Unido, marque el 00 en lugar del +)

sus opiniones son bienvenidas en

info@lorexcorp.com

para colocar pedidos de accesorios, visite

www.lorextechnology.com



En ligne:

le support des produits est disponible 24 heures sur 24, 7 jours sur 7, y compris les informations sur les produits, les guides de l'utilisateur, les guides de démarrage rapide et les foires à questions

www.lorextechnology.com/support

Pour commander des accessoires, visitez

www.lorextechnology.com



Par Courriel:

support technique (pour les questions techniques et d'installation) **support@lorexcorp.com**

OU

service à la clientèle (pour les questions de garantie et les ventes d'accessoires)

customerservice@lorexcorp.com

Commentaires des clients

info@lorexcorp.com



Par Téléphone:

NORTE AMÉRICA:

SERVICE À LA CLIENTÈLE: 1-888-425-6739 (1-888-42-LOREX)

SUPPORT TECHNIQUE: 1-877-755-6739 (1-877-75-LOREX)

MEXICO: 1-866-427-6739

INTERNACIONAL: +800-425-6739-0

(Exemple: À partir du Royaume-Uni, composez 00 au lieu de +)

nous serions heureux de recevoir vos

commentaires à info@lorexcorp.com pour

commander des accessoires, visitez

www.lorextechnology.com

BEFORE YOU START

THIS PRODUCT MAY REQUIRE PROFESSIONAL INSTALLATION

LOREX IS COMMITTED TO FULFILLING YOUR SECURITY NEEDS



- We have developed user friendly products and documentation. Please read the Quick Start Guide and User Manual before you install this product.

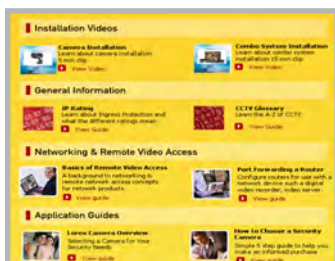

- Consumer Guides and Video Tutorials are available on our web site at www.lorextechnology.com/support



- If you require further installation assistance, please visit www.lorextechnology.com/installation or contact a professional installer.



- Please refer to the “Need Help” insert for technical support and customer care information.



- Please note that once the components of this product have been unsealed, you cannot return this product directly to the store without the original packaging.

AVANT DE COMMENCER

ANTES DE EMPEZAR

CE PRODUIT POURRAIT EXIGER UNE INSTALLATION PROFESSIONNELLE

ESTE PRODUCTO PUEDE EXIGIR UNA INSTALACIÓN PROFESIONAL

LOREX S'ENGAGE À SATISFAIRE VOS BESOINS SÉCURITAIRES

- Veuillez lire le guide de démarrage rapide et le mode d'emploi avant d'installer ce produit.
- Les guides du consommateur et les séances de tutorat vidéo sont disponibles sur l'Internet en visitant www.lorexttechnology.com/support
- Si vous avez besoin de l'aide pour l'installation, veuillez visiter www.lorexttechnology.com/installation ou contactez un spécialiste en installation
- Veuillez référer à l'insert "Need Help" pour obtenir de l'information sur le service à la clientèle et le support technique
- Veuillez constater qu'une fois que les composants de ce produit ont été retirés de l'emballage, vous ne pourrez plus retourner ce produit directement au magasin.

LOREX SE COMPROMETE A SATISFACER SUS NECESIDADES EN SEGURIDAD

- Favor de leer la guía de instalación rápida y la guía del usuario antes de instalar este producto.
- Puede conseguir las guías del consumidor y los cursos en enseñanza video sobre el Internet visitando www.lorexcctv.com/support
- Si necesita ayuda para la instalación, visite www.lorexttechnology.com/installation o contacte un especialista en instalaciones
- Favor de referir al documento "Need Help" para obtener información acerca del servicio al cliente y al soporte técnico
- Favor de notar que una vez que los componentes de este producto han sido removidos del embalaje, no podrá devolver este producto directamente a la tienda

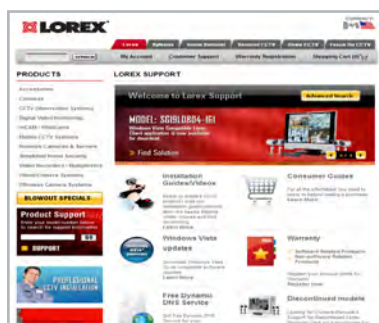

 **LOREX**[®]
www.lorexttechnology.com

April 27 2010 R3

Important Safeguards

In addition to the careful attention devoted to quality standards in the manufacture process of your video product, safety is a major factor in the design of every instrument. However, safety is your responsibility too. This sheet lists important information that will help to assure your enjoyment and proper use of the video product and accessory equipment. Please read them carefully before operating and using your video product.

Installation

1. **Read and Follow Instructions** - All the safety and operating instructions should be read before the video product is operated. Follow all operating instructions.
2. **Retain Instructions** - The safety and operating instructions should be retained for future reference.
3. **Heed Warnings** - Comply with all warnings on the video product and in the operating instructions.
4. **Polarization** - Do not defeat the safety purpose of the polarized or grounding-type plug.

A polarized plug has two blades with one wider than the other.

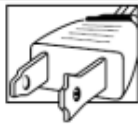

A grounding type plug has two blades and a third grounding prong.



The wide blade or the third prong are provided for your safety.

If the provided plug does not fit into your outlet, consult an electrician for replacement of the obsolete outlet

5. **Power Sources** - This video product should be operated only from the type of power source indicated on the marking label. If you are not sure of the type of power supply to your location, consult your video dealer or local power company. For video products intended to operate from battery power, or other sources, refer to the operating instructions.
6. **Overloading** - Do not overload wall outlets of extension cords as this can result in the risk of fire or electric shock. Overloaded AC outlets, extension cords, frayed power cords, damaged or cracked wire insulation, and broken plugs are dangerous. They may result in a shock or fire hazard. Periodically examine the cord, and if its appearance indicates damage or deteriorated insulation, have it replaced by your service technician.
7. **Power-Cord Protection** - Power supply cords should be routed so that they are not likely to be walked on or pinched by items placed upon or against them, paying particular attention to cords at plugs, convenience receptacles, and the point where they exit from the video product.

8. **Ventilation** - Slots and openings in the case are provided for ventilation to ensure reliable operation of the video product and to protect it from overheating. These openings must not be blocked or covered. The openings should never be blocked by placing the video equipment on a bed, sofa, rug, or other similar surface. This video product should never be placed near or over a radiator or heat register. This video product should not be placed in a built-in installation such as a bookcase or rack unless proper ventilation is provided or the video product manufacturer's instructions have been followed.

9. **Attachments** - Do not use attachments unless recommended by the video product manufacturer as they may cause a hazard.

10. **Camera Extension Cables** - Check the rating of your extension cable(s) to verify compliance with your local authority regulations prior to installation.

11. **Water and Moisture** - Do not use this video product near water. For example, near a bath tub, wash bowl, kitchen sink or laundry tub, in a wet basement, near a swimming pool and the like.

Caution: Maintain electrical safety. Power line operated equipment or accessories connected to this unit should bear the UL listing mark of CSA certification mark on the accessory itself and should not be modified so as to defeat the safety features. This will help avoid any potential hazard from electrical shock or fire. If in doubt, contact qualified service personnel.

12. **Accessories** - Do not place this video equipment on an unstable cart, stand, tripod, or table. The video equipment may fall, causing serious damage to the video product. Use this video product only with a cart, stand, tripod, bracket, or table recommended by the manufacturer or sold with the video product. Any mounting of the product should follow the manufacturer's instructions and use a mounting accessory recommended by the manufacturer.



Service

13. **Servicing** - Do not attempt to service this video equipment yourself as opening or removing covers may expose you to dangerous voltage or other hazards. Refer all servicing to qualified service personnel.
14. **Conditions Requiring Service** - Unplug this video product from the wall outlet and refer servicing to qualified service personnel under the following conditions.
 - A. When the power supply cord or plug is damaged.
 - B. If liquid has been spilled or objects have fallen into the video product.
 - C. If the video product has been exposed to rain or water.
 - D. If the video product does not operate normally by following the operating instructions. Adjust only those controls that are covered by the operating instructions. Improper adjustment of other controls may result in damage and will often require extensive work by a qualified technician to restore the video product to its normal operation.
 - E. If the video product has been dropped or the cabinet has been damaged.
 - F. When the video product exhibits a distinct change in performance. This indicates a need for service.
15. **Replacement Parts** - When replacement parts are required, have the service technician verify that the replacements used have the same safety characteristics as the original parts. Use of replacements specified by the video product manufacturer can prevent fire, electric shock or other hazards.
16. **Safety Check** - Upon completion of any service or repairs to this video product, ask the service technician to perform safety checks recommended by the manufacturer to determine that the video product is in safe operating condition.
17. **Wall or Ceiling Mounting** - The cameras provided with this system should be mounted to a wall or ceiling only as instructed in this guide, using the provided mounting brackets.
18. **Heat** - The product should be situated away from heat sources such as radiators, heat registers, stoves, or other products (including amplifiers) that produce heat.

Use

19. **Cleaning** - Unplug the video product from the wall outlet before cleaning. Do not use liquid cleaners or aerosol cleaners. Use a damp cloth for cleaning.
20. **Product and Cart Combination** - Video and cart combination should be moved with care. Quick stops, excessive force, and uneven surfaces may cause the video product and car combination to overturn.
21. **Object and Liquid Entry** - Never push objects for any kind into this video product through openings as they may touch dangerous voltage points or "short-out" parts that could result in a fire or electric shock. Never spill liquid of any kind on the video product.
22. **Lightning** - For added protection for this video product during a lightning storm, or when it is left unattended and unused for long periods of time, unplug it from the wall outlet and disconnect the antenna or cable system. This will prevent damage to the video product due to lightning and power line surges.

General Precautions

1. All warnings and instructions in this manual should be followed.
2. Remove the plug from the outlet before cleaning. Do not use liquid aerosol detergents. Use a water dampened cloth for cleaning.
3. Do not use this unit in humid or wet places.
4. Keep enough space around the unit for ventilation. Slots and openings in the storage cabinet should not be blocked.
5. During lightning storms, or when the unit is not used for a long time, disconnect the power supply, antenna, and cables to protect the unit from electrical surge.

FCC CLASS B NOTICE

Note

This equipment has been tested and found to comply with the limits for a Class B digital device, pursuant to Part 15 of the FCC Rules. These limits are designed to provide reasonable protection against harmful interference in a residential installation. This equipment generates, uses, and can radiate radio frequency energy and, if not in-stalled and used in accordance with the instruction, may cause harmful interference to radio communications.

However, there is no guarantee that interference will not occur in a particular installation. If this equipment does cause harmful interference to radio or television reception (which can be determined by turning the equipment on and off), the user is encouraged to try to correct the interference by one or more of the following measures:

- Reorient or relocate the receiving antenna
- Increase the separation between the equipment and receiver
- Connect the equipment into an outlet on a circuit different from that to which the receiver is connected
- Consult the dealer or an experienced radio or television technician for assistance

This equipment has been certified and found to comply with the limits regulated by FCC and EMC. Therefore, it is designated to provide reasonable protection against interference and will not cause interference with other appliance usage.

However, it is imperative that the user follows this manual's guideline to avoid improper usage which may result in damage to the unit, electrical shock and fire hazard injury.

In order to improve the feature functions and quality of this product, the specifications are subject to change without notice from time to time.



www.lorextchnology.com

System Features

- High performance network DVR
- H.264 compression for efficient storage and network speed ¹
- EDGE design for standalone (vertical and horizontal) or VESA mount (Wall & LCD) ²
- Small form factor (Edge & Edge+ 11.6"x7.2"x1.7 ; Edge mini 7.3"x 7.7x 1.8)
- 3D graphics for sharp, color rich, high contrast video
- DVI/VGA output for display on PC monitor or TV with DVI/VGA input (DVI to VGA adapter included)³, HDMI compatible⁴
- Pentaplex operation - View, Record, Playback, Back Up & Remotely Control the system simultaneously
- View and record at VGA resolution: up to 640x480 per channel
- Video output (up to) 1280 x 1024 @ 60 Hz
- Supports up to 2TB SATA HDD
- USB mouse included, USB flash drive backup
- 2-channel audio
- 4/1 Alarm input/output ⁵
- "FLEX" IR extender (Remote control does not require line-of-sight)⁶
- PTZ cameras supported , RS485 (included in Edge+ models only)
- Record on motion detection, schedule or continuous
- Internet Remote Functions: View, Search & Playback, Backup and Setup
- LOREX Instant Mobile Viewing on iPhone™, Blackberry™ Windows® Mobile and other compatible 3G smart phones⁷
- Exclusive LOREX Easy Connect Internet Set-up Wizard⁸
- PC (Microsoft Windows™ 7/Vista/XP compatible) using Internet Explorer® browser
- Apple Mac compatible using the Safari browser for multi-channel live viewing
- Free LOREX DDNS (Dynamic Domain Name Service) for advanced remote connectivity at all times
- Email notification of events

-
1. Recording capacity may vary based on recording resolution & quality, lighting conditions and movement in the scene.
 2. Easily mounts to the back of an LCD monitor with VESA standard mounting holes and an independent stand (monitor not included). Requires clear access to the 100 x100 mm VESA mounting holes.
 3. DVI output only on 8/16-channel Edge models and 4/8/16 Edge+ models; VGA output only on 4-channel Edge and Edge mini models.
 4. DVI to HDMI converter cable required (not included).
 5. Not included in Edge mini.
 6. Not included in Edge mini. Flex IR and remote control sold separately.
 7. Instant Mobile Viewing on Blackberry™, iPhone™ or Windows Mobile™ 6.0 and above: selectable one channel live viewing. Mobile phone data plan is required (not included). Router port forwarding required. For the latest smart phone compatibility list, check www.lorextechnology.com
 8. Requires a high speed internet connection and a router (not included).

TABLE OF CONTENTS

Getting Started	1
Lorex EDGE mini: Front Panel	2
Lorex EDGE: Front Panel	3
Lorex EDGE: Rear Panel	3
Lorex EDGE+ : Front Panel	5
Lorex EDGE+: Rear Panel	6
Basic Setup	8
1. Mount the System	8
2. Connect the Cameras	8
3. Connect the Monitor	8
4. Connect the Ethernet cable	8
5. Connect the Flex-IR Extender	8
6. Connect the Power	8
System Passwords	9
Mouse Control	9
Remote Control	10
Starting the System	11
Onscreen Display	11
4-channel	11
8/16-channel	13
Using the Split-Screen Selector	15
Live Viewing	15
Playback	15
Flexible Camera Assignment	16
Setting the Date and Time	17
Recording	18
Event Recording	18
Recording Audio	18
Playback	19
Playback Markers	20
Additional Search Markers	20
Event List	21
Channel Filter	21
Smart Search	22
Event Details	22
Searching for Recorded Data	23
Live Mode	23

<i>Playback Mode</i>	24
Taking Screenshots	25
Using Screenshots	26
Managing Passwords	27
Using the Password Wheel	27
Enabling and Disabling Passwords	27
Changing Passwords	28
Using the Main Menu	29
Camera	30
Setup	30
Record	31
4-channel	31
8/16-channel	32
<i>Schedule</i>	33
4/8/16-channel	33
<i>Format HDD</i>	34
Storage Calculator	34
Alarm	34
4-channel	34
8/16-channel	36
<i>Motion</i>	37
4/8/16-channel	37
Backup	38
<i>Formatting the USB Drive</i>	38
Confirming Backup	39
Backup File Information	39
Setting Quicktime as a default media player	39
LAN	40
<i>Easy Connect</i>	40
<i>LAN Password</i>	41
<i>Upgrading Firmware</i>	41
Changing Ports On Your System	42
REMOTE ACCESS: DVR Netviewer	46
System Requirements	46
Netviewer: Basic Layout	47
Network User Profiles	47
DVR Netviewer Main Screen	48
4-channel	48
8/16-channel	49
Live Viewing	50
Playback	50
Using the Pop-Up Calendar	50
Backup	51
Setup	52

<i>Bitrate</i>	52
<i>PPPoE</i>	52
<i>DDNS</i>	52
<i>System Status</i>	53
<i>Resuming Live Viewing</i>	53
<i>Mail</i>	54
<i>Title</i>	54
Setting up Local and Remote Viewing	55
<i>What do I need?</i>	55
Viewing your system through a Local Area Network	56
Finding your IP address and port number	56
<i>Connecting to your system</i>	57
<i>Connecting to your system on Internet Explorer (PC):</i>	57
<i>Connecting to the system using Safari (Mac)</i>	58
Setting Up Remote Connectivity	60
<i>Remote Connectivity Options</i>	60
Remote Viewing Using Easy Connect	61
Before You Get Started	61
Enabling Easy Connect	62
Upgrading The Firmware	62
Prep the USB Flash Drive	62
Download the firmware from the Lorex website	63
Upgrade the DVR firmware	63
Enabling Easy Connect on your DVR	63
Registering for an Easy Connect account	64
Connecting to your DVR using Easy Connect	66
How port forwarding works	68
Lorex Auto Port Forwarding Wizard	69
Installation	69
Obtaining Your Router Model Number and Version	70
Example	70
Configuration	71
Initial Startup: Select language	71
Step 1: Populate the router database	71
Step 2: Enter your router settings	72
Step 3: Update the router settings	73
Step 4: Test your connection	73
Configuring multiple routers	73
Scenario A: Router/Modem combination + Router	74
Scenario B: Multiple Routers	74
Example	75
Setting Up DDNS	76
Enabling DDNS on your system	77
Networking Checklist	78
Mobile Connectivity	80

Compatible Mobile Viewing Devices	80
Before You Begin	80
Mobile Connectivity on the iPhone / iPad	81
iPhone Users	81
Downloading the Lorex Live Application	81
Connecting To Your DVR - iPhone Users	81
The Lorex Live Interface	82
Connecting To Your DVR - iPad users	83
Mobile Connectivity on Windows Mobile	84
Connecting to your DVR using Mobile View	84
Mobile Connectivity on the Blackberry	85
Appendix A: System Specifications	89
EDGE SERIES DVR	89
Appendix A: System Specifications (cont'd.)	90
EDGE SERIES DVR	90
Product Information	90
Edge+and Edge Mini Specifications	91
Appendix B: Connecting Motion / Alarm Devices	94
PTZ Control Interface	97
Appendix C: Connecting Audio	99
Appendix D: Full Connectivity Diagram	101
Appendix E: Replacing the Hard Drive	104
<i>EDGE Series DVR</i>	104
EDGE+ DVR	106
Formatting the Hard Drive	110
Troubleshooting	111

GETTING STARTED

The system comes with the following components:



EDGE mini DVR (LH304)



USB Mouse



Power Adapter



Ethernet Cable



Mounting Kit
(Mounting Kit contents may differ from image)



Instruction manual, quickstart guide, documentation CD

Flex IR & remote control sold separately



EDGE DVR (LH310)



USB Mouse



DVI/VGA Adapter
(8 & 16 channel models only)



Remote Control



Flex-IR Extender



Power Adapter



Ethernet Cable



Mounting Kit
(Mounting Kit contents may differ from image)



Instruction manual, quickstart guide, documentation CD



EDGE+ DVR (LH320)



USB Mouse



DVI/VGA Adapter



Remote Control



Flex-IR Extender



Power Adapter



Ethernet Cable



Mounting Kit
(Mounting Kit contents may differ from image)



Instruction manual, quickstart guide, documentation CD

DVR MODEL, HARD DRIVE SIZE, NUMBER OF CHANNELS, AND CAMERA CONFIGURATION MAY VARY BY MODEL. PLEASE REFER TO YOUR PACKAGE FOR SPECIFIC DETAILS. CHECK YOUR PACKAGE TO CONFIRM THAT YOU HAVE RECEIVED THE COMPLETE SYSTEM, INCLUDING ALL COMPONENTS SHOWN ABOVE.

LOREX EDGE mini: Front Panel



1. **USB port:** Connect a USB flash drive for data backup and firmware updates (download from website).
2. **Power Indicator:** LED indicator for system power.
3. **HDD Indicator:** LED indicator for internal hard drive.

LOREX EDGE mini: Rear Panel

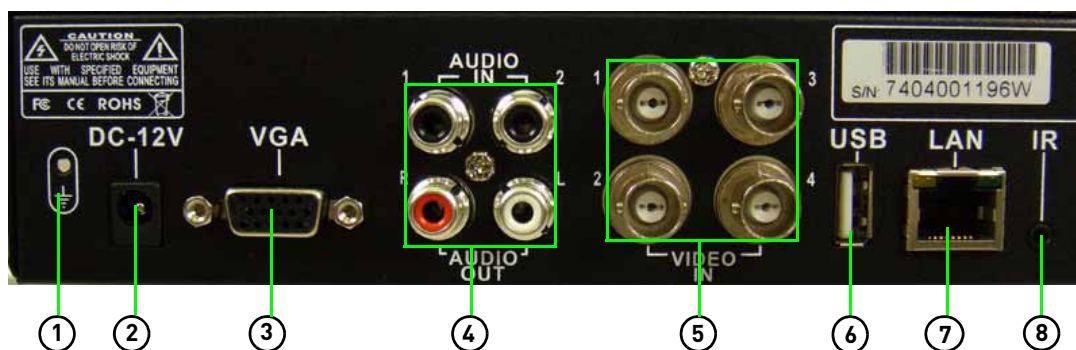

1. **GND:** Ground port.
2. **DC 12V:** Port for 12V DC, 2.5A power adapter (included).
3. **VGA:** Port to connect a VGA monitor (not included).
4. **Audio In:** Input ports for audio enabled cameras.
Audio Out: Output for two audio channels.
5. **Video In:** BNC input ports for 4 BNC cameras.
6. **USB Port:** Port for a USB mouse.
7. **LAN:** Networking port for a 10/100 Base-T RJ-45 network cable (included).
8. **Flex IR port :**Port for the Flex-IR Extender (Flex-IR Extender optional, not included).

Lorex EDGE: Front Panel

All models



1. **IR Receiver:** Internal IR receiver for the remote control.
2. **USB port:** Connect a USB flash drive for data backup and firmware updates (download from website).
3. **Power Indicator:** LED indicator for system power. When system is powered on, LED is lit red.
4. **HDD Indicator:** LED indicator for internal hard drive. When in continuous recording mode, LED pulses red.

Lorex EDGE: Rear Panel

4-channel models

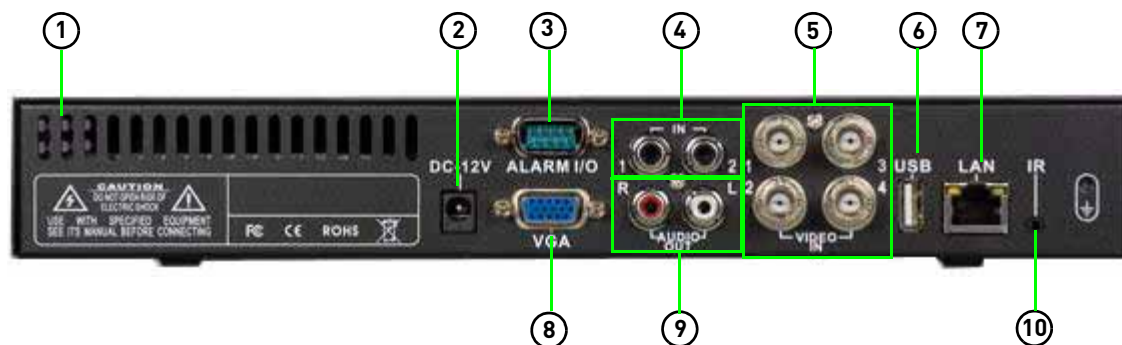

1. **Exhaust slots:** Slots to let heat escape from the internal hard drive. *Do not block.* Allow for proper ventilation.
2. **DC 12V:** Port for 12V DC 2.5 A power adapter (included).
3. **Alarm I/O:** Input/output port for alarm / relay (D-sub 9 connector required—not included).
4. **Audio In:** Input ports for audio enabled cameras.
5. **Video In:** BNC input ports for 4 BNC cameras.
6. **USB Port:** Port for a USB mouse.
7. **LAN:** Networking port for a 10/100 Base-T RJ-45 network cable (included).
8. **VGA:** Port to connect a VGA monitor (not included)
9. **Audio Out:** Output for two audio channels.
10. **IR:** Port for the Flex-IR Extender.
11. **Ground Port**

Lorex EDGE: Rear Panel

8-channel

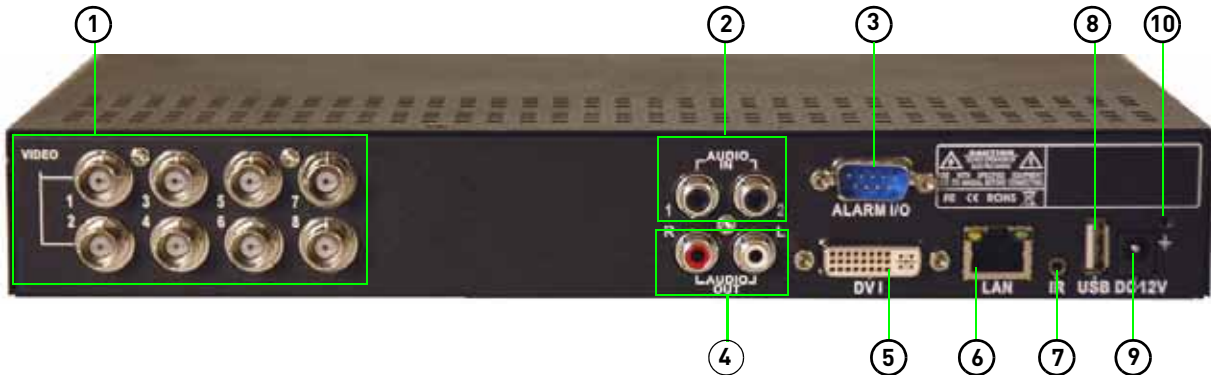

1. **Video In:** BNC input ports for 8 BNC cameras.
2. **Audio In:** Input ports for audio enabled cameras.
3. **Alarm I/O:** Input/output port for alarm / relay (D-sub 9 connector required—not included).
4. **Audio Out:** Output for two audio channels.
5. **DVI:** Port to connect a DVI monitor (not included).
6. **LAN:** Networking port for a 10/100 Base-T RJ-45 network cable (included).
7. **IR:** Port for the Flex-IR Extender.
8. **USB Port:** Port for a USB mouse.
9. **DC 12V:** Port for 12V DC 3 A power adapter (included).
10. **Ground Port.**

16-channel

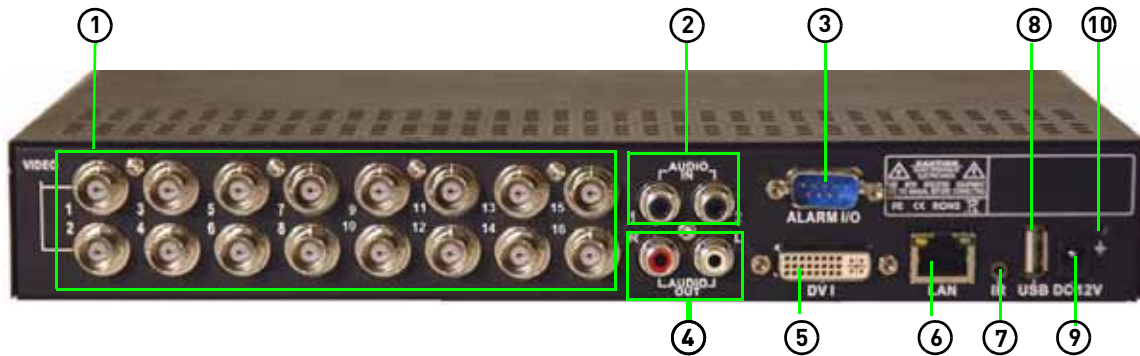





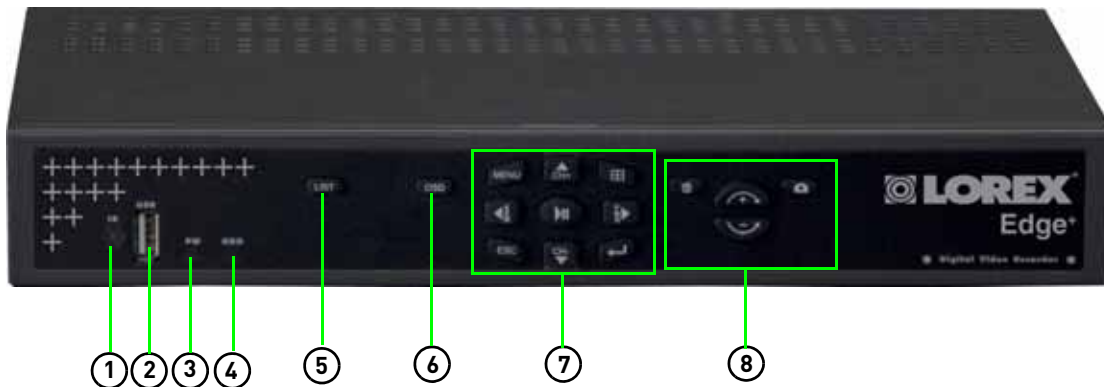

1. **Video In:** BNC input ports for 16 BNC cameras.
2. **Audio In:** Input ports for audio enabled cameras.
3. **Alarm I/O:** Input/output port for alarm / relay (D-sub 9 connector required—not included).
4. **Audio Out:** Output for two audio channels.
5. **DVI:** Port to connect a DVI monitor (not included).
6. **LAN:** Networking port for a 10/100 Base-T RJ-45 network cable (included).
7. **IR:** Port for the Flex-IR Extender.
8. **USB Port:** Port for a USB mouse.
9. **DC 12V:** Port for 12V DC 3 A power adapter (included).
10. **Ground Port.**

Lorex EDGE⁺ : Front Panel

All Models



1. **IR Receiver:** Internal IR receiver for the remote control.
2. **USB port:** Connect a USB flash drive for data backup and firmware updates (download from website).
3. **Power Indicator:** LED indicator for system power. When system is powered on, LED is lit red.
4. **HDD Indicator:** LED indicator for internal hard drive. When in continuous recording mode, LED pulses red.
5. **LIST:** Opens the Event List menu.
6. **OSD:** Show/hide the on-screen display.
7. **Primary Controls:**
 - **MENU:** Opens the system main menu.
 - : Press to open the Split-Screen Selection menu (8 / 16-channel only).
From full-screen single channel view, changes display view to Quad split-screen (4-channel model only)
 - **▲/CH+:** Move cursor in menus up; Channel Up.
 - **▶/FWD:** Move cursor in menus right; during playback, increase forward playback speed (5X, 15X, 60X).
 - **◀/REW:** Move cursor in menus left; during playback, increase reverse playback speed (5X, 15X, 60X)
 - **▶ / II :** Start/pause forward playback.
 - **▼/CH-:** Move cursor in menus down; Channel down.
 - **ESC:** Go back / exit menus.
 - : Confirm menu selections. Press twice in live viewing to access system information.
8. : While in Event List menu, press to delete a selected event (no confirm or undo).
 - : During Live Mode and Playback; Press to take a screenshot of the main display—USB flash drive must be connected (8/16-channel only).
 - Increase/Decrease buttons:
 - : Increase the value of selected menu option.
 - : Decrease the value of selected menu option.

Lorex EDGE⁺ : Rear Panel

4-channel

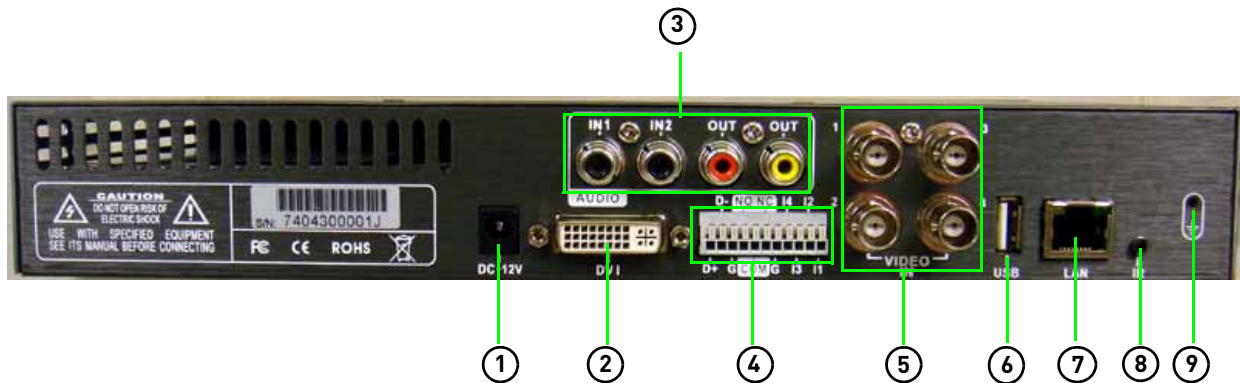

1. **DC 12V:** Port for 12V DC, 2.5A power adapter (included).
2. **DVI:** Port to connect a DVI monitor (not included).
3. **Audio In:** Input ports for audio enabled cameras.
Audio Out: Output for two audio channels.
4. **Alarm Block:** Input/output port for alarm / relay devices (i.e. PTZ cameras and sensors, not included).
5. **Video In:** BNC input ports for BNC cameras.
6. **USB Port:** Port for a USB mouse.
7. **LAN:** Networking port for a 10/100 Base-T RJ-45 network cable (included).
8. **IR:** Port for the Flex-IR Extender.
9. **Ground Port.**

8-channel

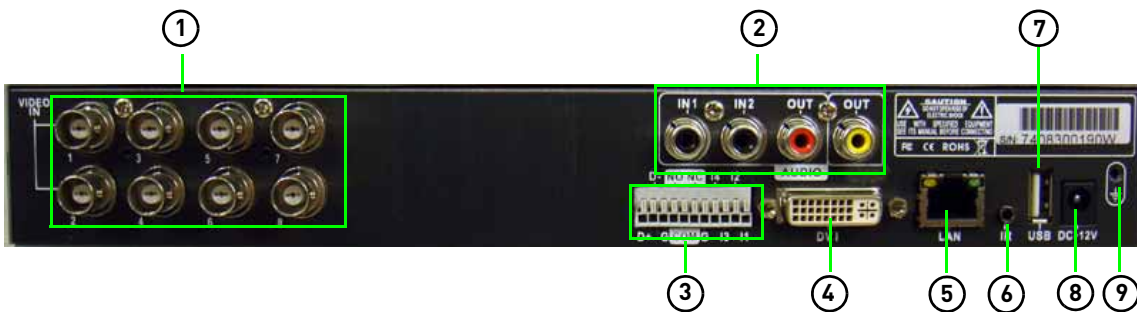

1. **Video In:** BNC input ports for BNC cameras.
2. **Audio In:** Input ports for audio enabled cameras (not included).
Audio Out: Output for two audio channels.
3. **Alarm Block:** Input/output port for alarm / relay devices (i.e. PTZ cameras and sensors, not included).
4. **DVI:** Port to connect a DVI monitor (not included).
5. **LAN:** Networking port for a 10/100 Base-T RJ-45 network cable (included).
6. **IR:** Port for the Flex-IR Extender.
7. **USB Port:** Port for a USB mouse.
8. **DC 12V:** Port for 12V DC, 3A power adapter (included).
9. **Ground Port.**

16-channel

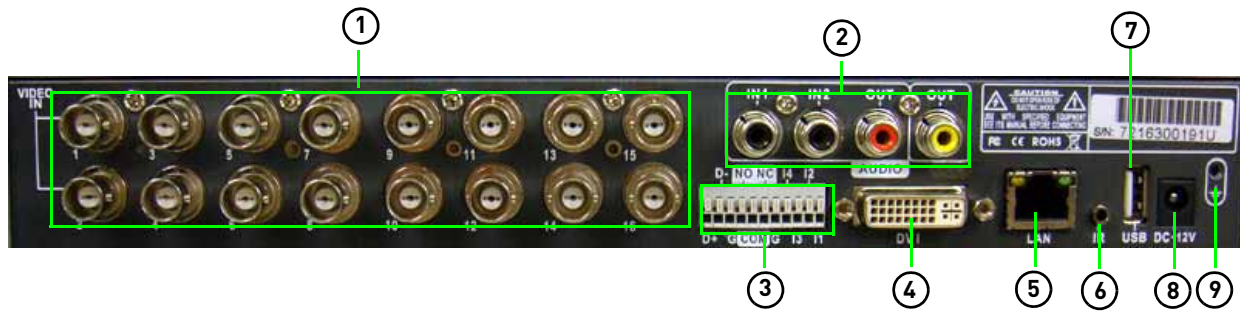

1. **Video In:** BNC input ports for 16 BNC cameras.
2. **Audio In:** Input ports for audio enabled cameras (not included).
Audio Out: Output for two audio channels.
3. **Alarm Block:** Input/output port for alarm / relay devices (i.e. PTZ cameras and sensors, not included).
4. **DVI:** Port to connect a DVI monitor (not included).
5. **LAN:** Networking port for a 10/100 Base-T RJ-45 network cable (included).
6. **IR:** Port for the Flex-IR Extender.
7. **USB Port:** Port for a USB mouse.
8. **DC 12V:** Port for 12V DC, 3A power adapter (included).
9. **Ground Port.**

Basic Setup

The system is designed to mount to the back of most LCD monitors with a VESA mount. If desired, you can mount it to a wall or leave the system in a standard horizontal or vertical position.

ATTENTION: You can only mount the system to an LCD monitor that has a VESA mount and an independent stand, with clear access to the VESA mount holes.

1. Mount the System

- a. Screw the provided mounting screws into the two top holes in the rear panel of your LCD monitor. Make sure the screws are only 3/4 of the way in; this will allow sufficient clearance to hang the system.
- b. Carefully place the system (front panel facing up) over the screws and slide down into place.

2. Connect the Cameras

- a. Connect BNC cameras to the BNC ports on the rear panel.

3. Connect the Monitor

- a. Connect the VGA / DVI cable (not included) from your LCD monitor to the VGA or DVI port on the rear panel of the system.

4. Connect the Ethernet cable

- a. Connect the included Ethernet cable to the LAN port on the rear panel of system; connect the other end of the Ethernet cable to an empty LAN port on your router (not included).

5. Connect the Flex-IR Extender

- a. Connect the Flex-IR extender to the port on the rear panel of the DVR. Position the Flex-IR extender near the front of your monitor, or where it will receive a clear signal from the remote control. Use a piece of double-sided tape (included) to help secure the Flex-IR Extender.

NOTE: The Flex-IR Extender is not required for normal operation. It may be necessary if there is not a clear line-of-sight between the DVR and the remote control. The Edge mini has an optional Flex IR extender and remote control.

6. Connect the Power

- a. Connect the power cord to the DC12V port in the rear panel of the system.

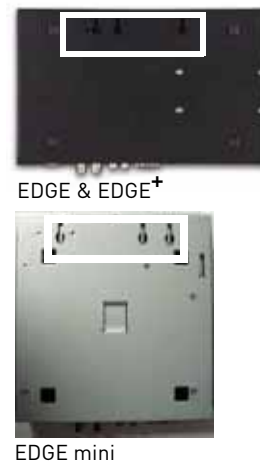

Figure 1.0 Mounting holes on bottom panel



Figure 1.1 Mount the system to the monitor



Figure 1.2 Connect the Ethernet cable

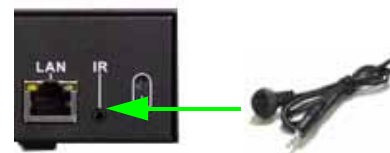

Figure 1.3 Connect the Flex IR extender (Available as an optional accessory for the EDGE mini)

System Passwords

Depending on your system model, the default user name (ID) and password is different. Refer to the tables below for details on the default system user IDs and passwords.

Local DVR Access

4 Channel			8 & 16 Channel		
LEVEL	ID	PASSWORD	LEVEL	ID	PASSWORD
USER	1	1111	USER	2	2222
ADMIN	2	2222	ADMIN	3	3333

Remote/LAN Viewing

4/ 8/ 16 Channel		
LEVEL	ID	PASSWORD
GUEST	7	1111
USER	8	2222
ADMIN	9	3333

Mouse Control

The mouse is the primary input device for navigating system menus.

NOTE: Unless otherwise noted, all system functions described in this manual are achieved through mouse input.

To use a mouse with the system:

1. Connect a **USB mouse** to the USB port on rear panel of the system.

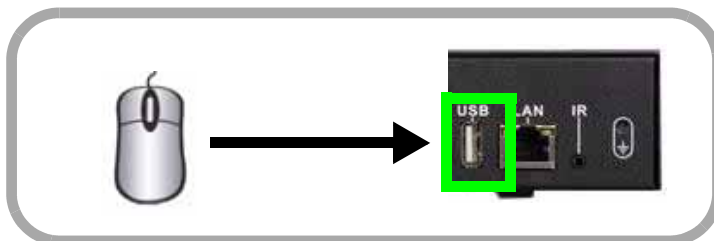

Figure 2.0 Connect a USB mouse to the USB port on the rear panel



Tip!

Connect the mouse to the USB port on the rear panel to allow for easy access of a USB backup device using the front panel.

2. Use the mouse buttons to perform the following:
 - **Left-Button:** Click to select a menu option; while in Split-Screen mode (Live View or Playback), click on a channel to view the selected channel in full-screen.
 - **Right-Button:** Click to return to previous menu; exit menus/modes.
3. **Scroll-Wheel:** Scroll up/down to change values in selected menu options; position markers in playback bar.

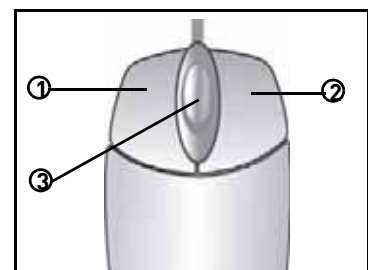

Figure 2.1 Mouse button operation

Remote Control

The remote control is the secondary input device for navigating the system's graphical user interface.

To use the remote control:







1. **LIST**: Open the Event List menu.
2. **OSD**: Show/hide the on-screen display.
3. Primary controls:
 - **MENU**: Opens the system main menu.
 - : Press to open the Split-Screen Selection menu (*8 / 16-channel only*).
From full-screen single channel view, changes display view to Quad split-screen (*4-channel model only*)
 - **▲/CH+**: Move cursor in menus up; Channel Up.
 - **▶/FWD**: Move cursor in menus right; during playback, increase forward playback speed (5X, 15X, 60X).
 - **◀/REW**: Move cursor in menus left; during playback, increase reverse playback speed (5X, 15X, 60X)
 - **▶ / II**: Start/pause forward playback.
 - **▼/CH-**: Move cursor in menus down; Channel down.
 - **ESC**: Go back / exit menus.
 - : Confirm menu selections.
4. : While in Event List menu, press to delete a selected event (no confirm or undo).
5. : During Live Mode and Playback, Press to take a screenshot of the main display—USB flash drive must be connected (8/16-channel only).
6. Increase/Decrease buttons:
 - : Increase the value of selected menu option.
 - : Decrease the value of selected menu option.



Figure 3.0 Remote Control

STARTING THE SYSTEM

To power the system ON:

- Connect the power cable to the DC 12V port on the rear panel of the system

At startup, the system performs a basic system check and runs an initial loading sequence. After a few moments, the system loads a live display view (*Live Mode*).

NOTE: Make sure all cameras and cables are properly connected prior to powering on the system.

Onscreen Display

4-channel

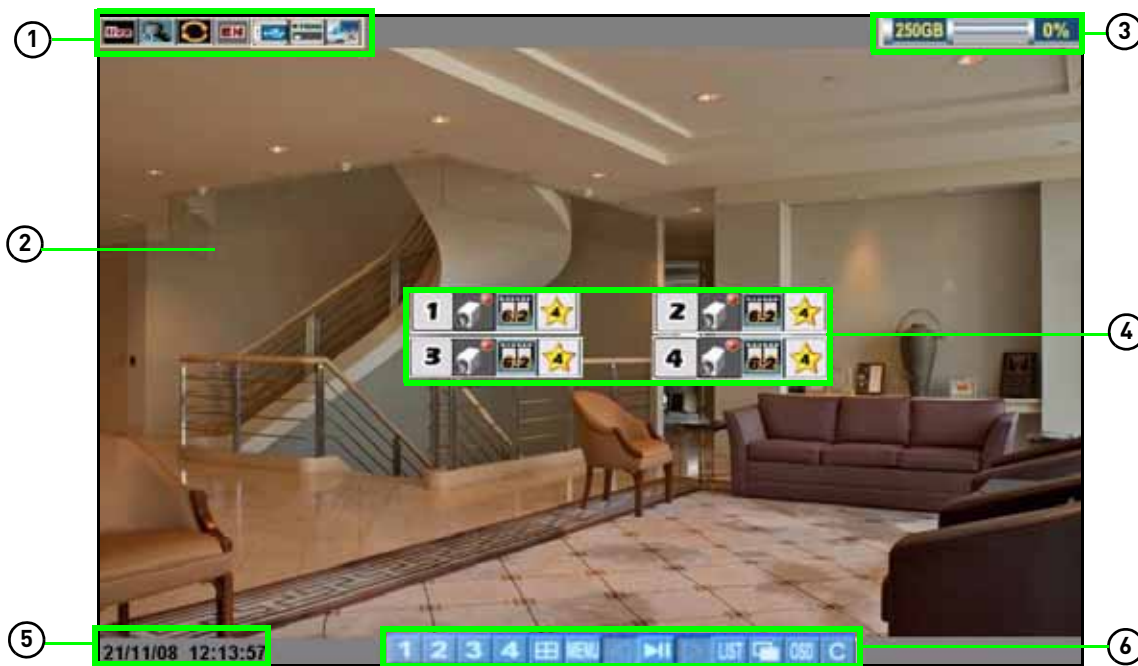

Figure 4.0 Live viewing with on-screen display (4-channel model)

1. **System Status Bar:** Displays mode, password type, recording mode, language, and status of devices (HDD and USB).



2. **Display:** Full-screen single channel and Quad split-screen available in Live Viewing and Playback modes; if cameras are disconnected, channels display a blue screen with the text, "VLOSS."

3. **HDD Status:** Displays the recording space consumed on the hard disk (%) and the size of the pre-installed hard drive. For example, 250 GB.



4. **Camera Status:** Displays channel number, recording status, frame rate, and video quality.



5. **Date/Time:** Displays the date and time on the system.

6. **Toolbar:** Primary control input for the user interface:



Toolbar icons are based on firmware version **7.28.08_1890C** (4-channel) and **1.45.08_1890C** (8 & 16 channel) and above. To check your firmware version, press the button twice on the remote.

- : Click to view channel 1 in full-screen.
- : Click to view channel 2 in full screen.
- : Click to view channel 3 in full screen.
- : Click to view channel 4 in full screen.
- : Click to view Quad split-screen mode (Live View and Playback modes).
- : Click to open the system Main Menu. See “Using the Main Menu” on page 29.
- : While in Playback mode, click to increase reverse playback speed (5X, 15X, 60X).
- : From Live View, click to open Playback Mode; click to pause/play video.
- : While in Playback mode, click to increase forward playback speed (5X, 15X, 60X).
- : Click to open the Event List menu. See “Event List” on page 21.
- : Click to begin sequence view.
- : From the Event List menu, click to delete a selected video file.

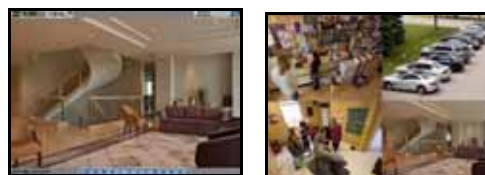

Figure 4.1 Single channel and Quad (4-channel model)

- NOTE:** Be careful when clicking the Trash icon—there is no confirmation for deletion and you *cannot* undo the action.
- : Click to show/hide the on-screen display (OSD).
 - : Click to return to the previous menu, and/or quit menus/modes
 - : Opens the PTZ menu (PTZ camera required ,not included, EDGE+ LH320 Series only).

8/16-channel



Figure 4.2 Live viewing with onscreen display (16-channel model shown)

1. **Display Screen:** Shows live and recorded video—single, quad, and split-screen (16-split on 16-channel model *only*).
2. **Camera Number/Title:** You can set the display to show the Camera Number, Title, or show no title.
3. **Channels:** Displays channels on the system. Icons flash red to indicate recording is in progress.
4. **Date/Time:** Displays the date and time on the system.
5. **HDD Status:** Displays the recording space consumed on the hard disk (%) and the size of the pre-installed hard drive. For example, 250 GB. **This reading is an approximation.**



6. **Toolbar:** Primary control input for the user interface (certain buttons will not be available at all times):

















EDGE (LH310 series) , Edge mini (LH304)



EDGE+ (LH320 series)

Figure 4.3 Toolbar differences between the EDGE, EDGE+ and EDGE mini.

- : Click to open the Split-Screen Selector; from full-screen (Live Mode only), click once to view quad, click again to open Split-Screen Selector. See “Using the Split-Screen Selector” on page 15.
 - : Click to open the system Main Menu. See “Using the Main Menu” on page 29.
 - : Click to select a menu option (left).
 - : Playback mode only—click to increase reverse playback speed (5X, 15X, 60X).
 - : From Live View, click to open Playback Mode; click to pause/play video.
 - : Click to select a menu option (right).
 - : While in Playback mode, click to increase forward playback speed (5X, 15X, 60X).
 - : Click to open the Event List menu. See “Event List” on page 21.
 - : Click to begin sequence view.
 - : Click to show/hide the on-screen display (OSD).
 - : Click to return to the previous menu, and/or quit menus/modes
 - : Opens the PTZ menu (PTZ camera required, not included, EDGE+ (LH320 series only)).
 - : From the Event List menu, click to delete a selected video file.
- NOTE:** Be careful when clicking the Trash icon—there is no confirmation for deletion and you *cannot* undo the action.
- : Click to take a snapshot of the active display (live viewing or playback) (8 or 16 channel models only).

NOTE: USB flash drive must be connected. For more details, see “Troubleshooting” on page 111.



Using the Split-Screen Selector

ATTENTION: Split-Screen Selector is only available on *8/16-channel models only*.

If your system has 8/16-channels, you must choose a split-screen configuration using the Split-Screen Selector built into the system's interface. The Split-Screen Selector allows you to choose the grid configuration for the main display during live viewing and playback: quad, 9-split, or 16-split (16-channel *only*).

Live Viewing

To use the Split-Screen Selector:

1. Click  to open the Split-Screen Selector. If you are in full-screen, click  to view quad, then click  again to open the Split-Screen Selector. Grid configurations appear in circles onscreen.
2. Click a grid configuration for live viewing:
 - *8-channel*: Choose from quad (CH1~4, CH5~9) or 9-split (CH1~8; the bottom-right square will remain blacked out).
 - *16-channel*: Choose from quad (CH1~4, CH5~9, CH9~12, CH13~16), 9-split (CH1~9, CH10~2), or 16-split (CH1~16).

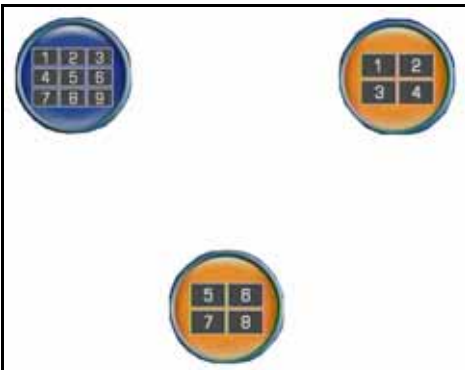

Figure 4.4 Split-Screen Selector (8-channel)

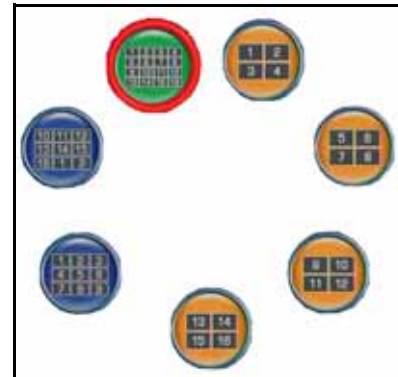



Figure 4.5 Split-Screen Selector (16-channel)

Playback

To use the Split-Screen Selector:

1. During playback, click  at anytime to open the Split-Screen Selector.

NOTE: The Split-Screen Selector will open even if you are viewing playback in full-screen.
2. Click a grid configuration for playback.

Flexible Camera Assignment

You can re-assign camera channels to different positions. For example, you can duplicate the video feed from channel 1 onto channel 2. This is useful if you wish to re-arrange the position of each channel.

NOTE: This feature is available on 8/16 channel systems only.

NOTE: The system continues to record the designated channel even if you re-assign camera positions.

EXAMPLE

Channel 3 is re-assigned to channel 5.



Figure 4.6 Re-assigning camera positions.

To re-assign camera positions:

1. Select the channel you want to have re-assigned.
2. Click and hold the mouse.
 - A channel menu appears.



Figure 4.7 The channel menu.

3. While holding left-click, move the mouse to the left or right to change the channel number.
4. Release left-click on the mouse to assign the new channel.

SETTING THE DATE AND TIME

It is highly recommended to immediately set the date and time when first setting up your system.

To set the date and time:



1. Click  to open the Main Menu.
2. Click  to open the Setup menu.
3. Click **Date/Time Setup** and configure the following options:
 - **Date Mode:** Use the scroll wheel to select **Y/M/D**, **D/M/Y**, or **M/Y/D**.
 - **Date:** Use the scroll wheel to manually enter the date.
 - **Time:** Use the scroll wheel to manually enter the time.
4. Click **Exit/Update**. The new date and time are saved; the system returns to the Setup menu.
5. Right-click to exit until all menus are closed. The date and time will appear on the bottom-left corner of the screen.



Figure 5.0 Clock menu



RECORDING

By default, the system is set to immediately record video from connected cameras in Continuous Record Mode.

You can set the system to stop recording once the hard drive is full, or to continually record by overwriting previously recorded data. For more details, see “Record” on page 31.

Event Recording

The system includes three modes of event recording:

-  **Motion:** The system records when motion is detected by the affected camera.
-  **Alarm:** The system records when an alarm or sensor is triggered.
-  **Video Loss:** The system records when a camera is disconnected or suffers video loss. The system employs a pre-record function to capture video seconds before the video loss occurred.

Recording Audio

The system can record two audio channels (on channel 1 and 2 only). You must have audio enabled cameras connected to the system in order to use this function.

PLAYBACK

View recorded video on the system through playback mode.















Figure 6.0 Playback display view

25/11/08 11:47:13

The playback time appears in the bottom-right corner of the screen.

To begin playback:

1. From the main screen, click  . Playback mode opens.
NOTE: If toolbar is not visible, first click  .
2. Select and change the date, month, year, time, and/or frame for playback and click  .
3. During playback, you have access to the following:
 -  : Click to pause playback; press again to resume playback.
 -  : Click to increase reverse playback speed (5X, 15X, 60X).
 -  : Click to increase forward playback speed (5X, 15X, 60X).
 -  : Click to open the Split-Screen Selector (8/16-channel *only*); Click to view playback in Quad mode (4-channel *only*)
 -  : Click to open the Event List menu. See “Playback Mode” on page 24.
4. Click any channel to view the selected channel in full-screen; or click  ,  ,  ,  .
5. Click anywhere in the playback bar to set a playback marker. Playback Markers can be used for faster searching in the Event List. See “Playback Markers” on page 20.
6. Right-click anywhere on the screen to exit.

Playback Markers

During playback, click anywhere in the playback bar to set a playback marker. Use this orange-colored marker for reference in future searches.



Additional Search Markers

The Playback bar can also be populated with other multi-colored markers. These markers are part of the *Smart Search* functionality of the system. For more details on Smart Search, see “Event List” on page 21.

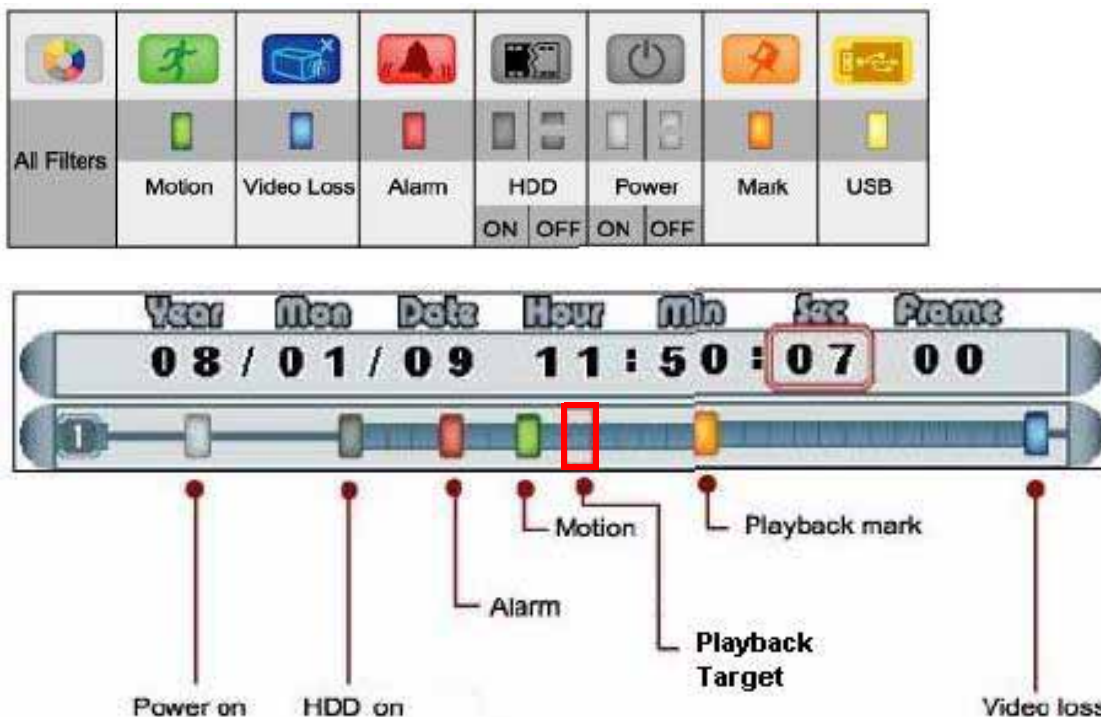



Figure 6.1 Playback display view

To use the search markers:

1. Using the mouse, scroll up/down to position one of the colored markers in the **Playback Target**.
2. Click .

EVENT LIST

The system features an Event List to organize and search for recorded video on the system. The Event List, coupled with the Smart Search icons, allows you to search for recorded data on your system quickly and easily.

NOTE: The system can save a maximum of 4096 events (4-channel) / 8192 events (8 & 16-channel).



Figure 7.0 Event List

1. **Channel Filter:** View data from all, or individual cameras.
2. **Smart Search:** Filter events through Smart Search icons.
3. **Event Details:** View details for the event, including date & time and event source.
4. **Events:** List of recorded events on the system.
5. **Active Toolbar Buttons:** While in Event List, use Play/Pause, Trash (delete), and C (Escape).

NOTE: The Escape button is only on Edge and Edge mini models. Screenshot button appears on 8/16-channel models.

Channel Filter

Use the Channel Filter to sort the data from individual channels or all channels.



Smart Search

Click the Smart Search icons to filter data according to events. These Smart Search icons are mirrored as event markers in Playback and Backup modes.



Figure 7.1 Smart Search Icons

Event Details

The event details (event number, camera on/off, filter type, date & time, and event source) immediately match the list of events. When you use the Camera filter and Event filter, the Event Details bar can help you view the pertinent information for the data.

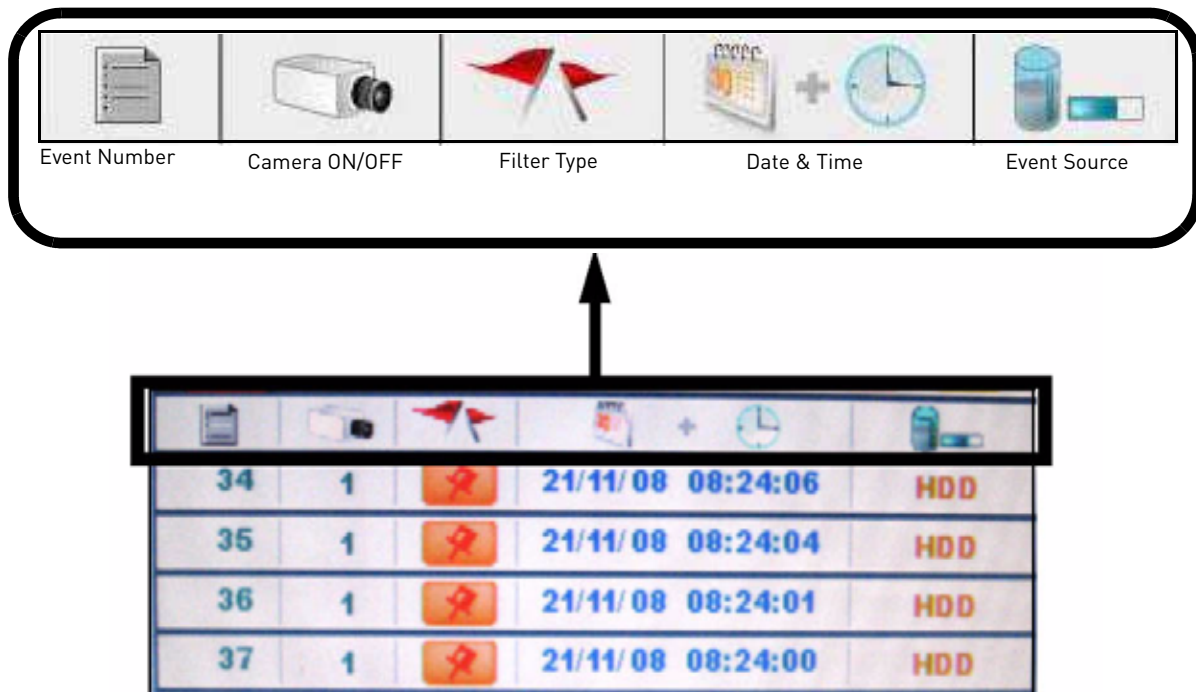















Figure 7.2 Event Details icons

Searching for Recorded Data

You can use the Event List from Live Mode and Playback Mode to search for recorded data on your system.

Live Mode

To search for data:

1. From the main screen, click . The Event List opens.
2. Under Channel Filter, click  to view events for *ALL* channels, or click the **Channel icons** to view events from *individual* channels.
3. Click the **Smart Search icons** to sort the data according to the following:
 -  **ALL:** View all events chronologically.
NOTE: USB backups appear at the top of the list if the USB flash drive with saved backup data is connected.
 -  **Motion:** Motion events from the connected cameras.
 -  **Video Loss:** Cameras are disconnected or suffer video loss. The system employs a pre-record function to capture video seconds before the loss of video occurred.
 -  **Alarm:** Alarm or sensor events on the system.
 -  **HDD ON/OFF:** Disconnection, power loss, or disk failures on the hard drive.
 -  **Power ON/OFF:** System ON/OFF.
 -  **Mark:** A personal marker set by the user during Playback Mode.
 -  **USB:** USB backup performed by the user
4. Scroll up/down to view the events on the list.
5. Click an event and then click . System switches to Playback Mode.
NOTE: You cannot begin playback after clicking  or 
6. To exit, right-click until you return to the main screen.

Playback Mode

To search for data:

1. From the main screen, click . Playback mode opens.

NOTE: If toolbar is not visible, first click .

2. Click . The Event List opens.



NOTE: Click  for Edge 8/16-channel models.



3. Under Channel Filter, click  to view events for *ALL* channels, or click the Channel icons to view events from *individual* channels.

4. Click any of the **Smart Search icons** to filter your search.

5. Scroll up/down to view the events on the list.

6. Click an event from the Event List and then click . Playback begins for the selected file.

NOTE: You cannot begin playback after clicking  or .

You can click  while a file is playing. Playback will pause. Select a new file from the Event List and then click  to play the file.

TAKING SCREENSHOTS

ATTENTION: 8/16-channel models only.

If your system has 8 or 16 channels, you can take screenshots (screen captures) of the main display of your system. You can take a screenshot at any time: during live viewing, search, and playback, or in any system menu. Screenshots are useful if you need to provide a still image of your security footage to the authorities.

NOTE: A USB flash drive must be connected and formatted to the system in order to take screenshots.

To take a screenshot:

1. Connect a USB flash drive (not included) to the USB port on the front panel of the system. Format the USB flash drive if you have not already done so. For more details, see “Formatting the USB Drive” on page 38.
2. If you want to capture a point in live viewing or playback, select the display view for the screenshot: single, quad, or split-screen.
3. Click . The screenshot will appear in the centre of the main display, followed by the file name. Screenshots are saved to the *Picture folder* on the USB flash drive.



Figure 7.3 Screenshot being taken on the system

NOTE: Screenshots are saved as JPEG files with the following naming convention: KMMDD00x.jpg

Filename	Definition
K	System file marker (all screen caps begin with <i>K</i>)
MM	Month
DD	Day
x	Numeral (i.e. 001, 002, 003, etc.)

Using Screenshots

Once you have taken screenshots, you need to connect the USB flash drive to a PC to view, print, or archive the images.

To use screenshots:

1. Connect the USB flash drive to a USB port on your PC. In the AutoPlay window, select **Open folder to view files**.

NOTE: If AutoPlay does not start, search your computer for a *Removable Disk*.

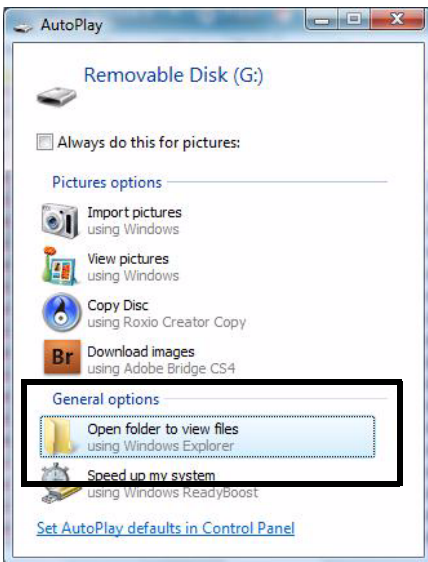

Figure 7.4 AutoPlay screen

2. Double-click the **Picture folder**.
3. Perform one of the following:
 - *View*: Double-click the screenshot to view it in an imaging program, such as Windows Picture Viewer or Adobe® Photoshop™
 - *Archive*: Copy the images to a folder on your computer
 - *Print*: Select the image and print it directly from Windows Explorer, or print the screenshot from an imaging program

MANAGING PASSWORDS

Refer to the tables below for the user name (ID) and password required to log in to your system:

Local DVR Access

4 Channel			8 & 16 Channel		
LEVEL	ID	PASSWORD	LEVEL	ID	PASSWORD
USER	1	1111	USER	2	2222
ADMIN	2	2222	ADMIN	3	3333

Remote/LAN Viewing

4/ 8/ 16 Channel		
LEVEL	ID	PASSWORD
GUEST	7	1111
USER	8	2222
ADMIN	9	3333

Using the Password Wheel

The system uses a graphical Password Wheel for inputting and changing user IDs and 4-digit, numeric passwords.

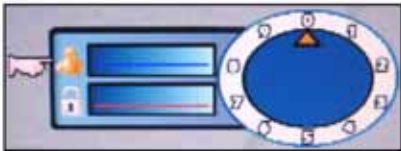

Figure 8.0 Login with your user ID and password using the Password Wheel

To use the Password Wheel:



- Using the mouse, move the cursor and click from **0~9**.

You cannot select the options to the left of the Password Wheel (user ID, password)—you can *only* select the digits. If you make a mistake, simply right-click to exit and re-select the option to try again.

Enabling and Disabling Passwords

By default, passwords are disabled when you first startup the system. With passwords enabled, you need to enter your user ID and password whenever you access the system Main Menu, Event List, or Playback mode.

To enable/disable passwords:

1. Click  to open the Main Menu. If necessary, login to the system.
2. Click . The Setup menu opens.
3. Click **Password Enable** and scroll up/down to select **0** to enable passwords, or **X** to disable.
4. To exit, right-click until you return to the main screen.

Changing Passwords

You need to be logged in as the administrator in order to change passwords on the system.

To change passwords:

1. Click  to open the Main Menu.

NOTE: In older firmware models, click  .

2. Click  . The Setup menu opens.
3. Click **DVR Password**. The Password Wheel opens.
4. Log in as the administrator.
5. Click either **User Password** or **Admin Password**.
6. Use the Password Wheel to input a 4-digit password. Input it again to confirm.



Figure 8.1 Password change

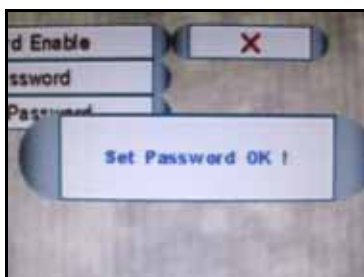



Figure 8.2 Password confirmation

7. To exit, right-click until you return to the main screen.

USING THE MAIN MENU

Depending on your DVR model:

- Click  to open the Main Menu **OR**
- Click  to open the Main Menu

NOTE: If passwords are enabled on the system, you need to select your user ID and enter the four-digit numerical password to open the Main Menu. See “Managing Passwords” on page 27.

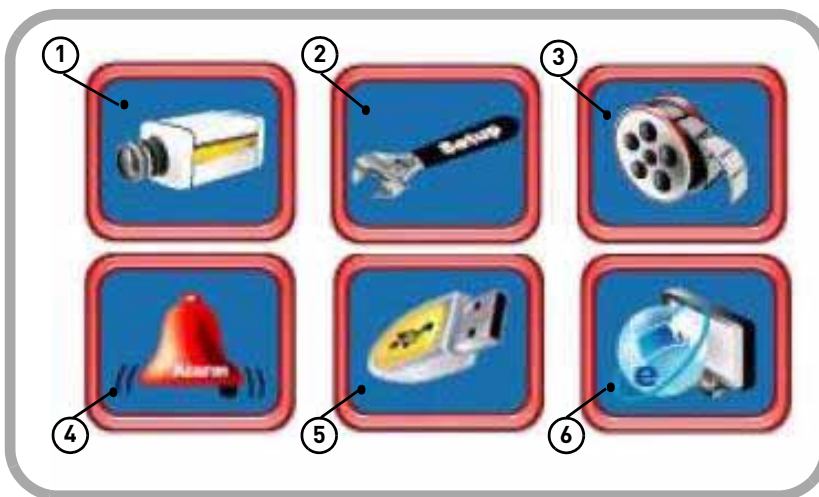

Figure 9.0 System Main Menu

1. **Camera:** Adjust Brightness, Contrast, Hue, and Saturation for each camera.
2. **Setup:** Configure Date/Time, Language, video system, passwords, and view system information.
3. **Record:** Configure recording parameters for Alarm/Motion recording, and working/non-recording; adjust video quality, resolution, set record mode, schedule, and format the hard drive
4. **Alarm:** Configure alarm, motion, and video loss settings.
5. **Backup:** Set backup parameters; format connected USB flash drive.
6. **LAN:** View/configure networking settings.



TIP!

When navigating menus:

Left mouse button:
Click to select menu options

Scroll-Wheel: Scroll up/
down to change values for
selected options

Camera

Configure display settings for each camera.

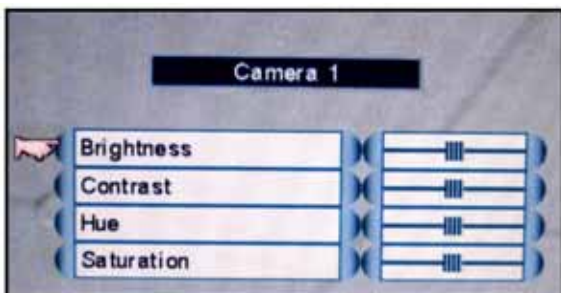





Figure 10.0 Camera menu

To configure camera color settings:

1. From the Main Menu, click . The Camera menu opens.
2. Select **Color Adjust**.
3. Click camera **1, 2, 3, or 4**. The video settings menu opens.
4. Configure the following:
 - **Brightness**
 - **Contrast**
 - **Hue**
 - **Saturation**
5. Scroll up/down to increase/decrease the value for the selected option.
6. To save your settings, right-click until you return to the main screen.

To configure camera sequence dwell settings (Edge+, Edge Mini only):

1. From the Main Menu, click . The Camera menu opens.
2. Click on **Sequence Time**.
3. Scroll the mouse wheel to adjust the sequence duration.
 - To begin a sequence, click  in the menu bar.

NOTE: Sequence Time refers to the time the camera channel changes to the next camera channel (in single channel view).

Setup

Set date/time, system language, passwords, and view system information.

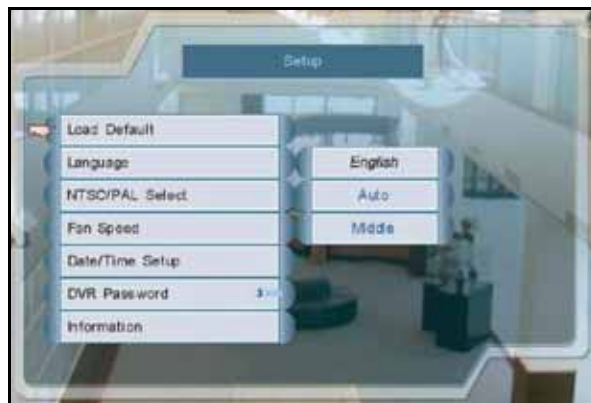

Figure 11.0 System Setup

To configure Setup settings:

1. From the Main Menu, click . The Setup menu opens.
2. Configure the following:
 - **Load Default:** Click to load default factory settings.
 - **Language:** Select **English, Traditional Chinese, Spanish, Russian, Italian, Simplified Chinese, Japanese, German, French, Dutch, Czech, Polish, Hebrew, Thai, Danish, Finnish, Swedish, Vietnamese, Turkish and Korean.**

NOTE: The new language is reflected in the status bar in the top-left corner (4-channel *only*).



Figure 11.1 System Languages

- **NTSC/PAL Select:** Scroll up/down to select NTSC (I.e. North America), PAL (I.e. Europe), or AUTO. If AUTO, the system will automatically detect the format of the connected cameras.

- **Fan Speed:** Click to set the fan speed to Low, Middle, or High. The higher the fan speed the cooler the HDD temperature (8/16-channel *only*).
 - **Date/Time Setup:** Click to open Date/Time Setup. See “Setting the Date and Time” on page 17.
 - **DVR Password:** Click to open the password menu. See “Managing Passwords” on page 27.
 - **Information:** Click to view system information: software, hardware, disk, and LAN.
3. To save your settings, right-click until you return to the main screen.

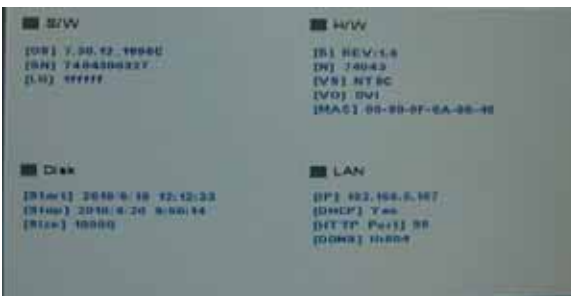

Figure 11.2 System information

Record

Set recording parameters, image quality, resolution, set the recording schedule, and format the hard drive.

4-channel



Figure 12.0 Record menu

NOTE: As you make changes to the recording parameters, the storage calculator at the bottom of the menu displays the time remaining on the hard drive.

To configure record settings:

1. From the Main Menu, click . The Record menu opens.
2. Configure the following:
 - **Alarm/Motion Rate:** Click under each camera and select **X, 2, 3, 5, 7.5, 10,** or **15** (fps).
 - **Working Hour Rate:** Click under each camera and select **0, 2, 3, 5, 7.5, 10,** or **15** (fps).
 - **Non-working Hour Rate:** Click under each camera and select **0, 2, 3, 5, 7.5, 10,** or **15** (fps).

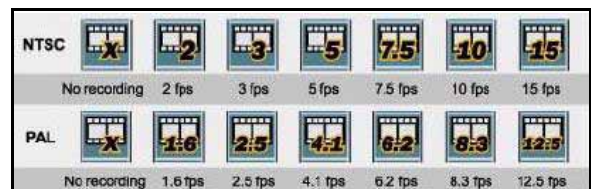

Figure 12.1 Frame rates for NTSC and PAL

- **Quality:** Click under each camera and select **1, 2, 3, 4,** or **5**.



Figure 12.2 Set image quality: 1 basic ~ 5 excellent

- **Audio:** Click under each camera and select either **0** to enable audio or **X** to disable audio.

NOTE: Audio is only available on channels 1 and 2.



- **Resolution:** Click to set the resolution for all cameras—**640x240** or **640x480**.



TIP!

To enable motion recording only, set the Working and Non Working hour frame rates to 0. Motion recording in the **Alarm menu** must also be enabled.

- **Record Mode:** Select one of the following:

-  **Single-Way:** The system stops recording when the internal hard drive is full.
-  **Overwrite:** The system continues recording when the internal hard drive is full by overwriting the oldest recorded data.
-  **No Record:** The system *does not* record.

3. To exit, right-click until you return to the main screen.



8/16-channel





Figure 12.3 Record menu (8/16-channel)

NOTE: As you make changes to the recording parameters, the storage calculator at the bottom of the menu displays the time remaining on the hard drive.

To configure record settings:

1. From the Main Menu, click . The Record menu opens.
2. Configure the following:
 - **Video Information:** View video quality statistics
 - **Record Mode:** Click to select one of the following:
 -  **Single-Way:** The system stops recording when the internal hard drive is full.

-  **Overwrite:** The system continues recording when the internal hard drive is full by overwriting the oldest recorded data.
 -  **No Record:** The system *does not* record.
- **Video Frame Rate:** Set the frame rates for alarm/motion, working hour, and non-working hour:

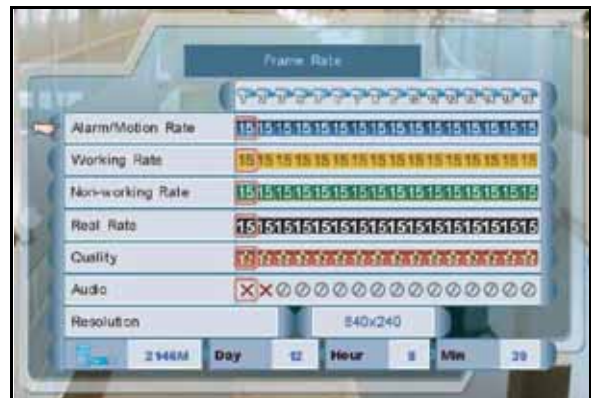

Figure 12.4 Frame Rate menu (8/16-channel only)

- **Alarm/Motion Rate:** Click under each camera and select **X, 2, 3, 5, 7.5, 10, or 15** (fps).
- **Working Hour Rate:** Click under each camera and select **0, 2, 3, 5, 7.5, 10, or 15** (fps).
- **Non-working Hour Rate:** Click under each camera and select **0, 2, 3, 5, 7.5, 10, or 15** (fps).

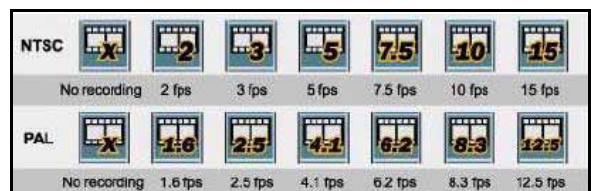

Figure 12.5 Frame rates for NTSC and PAL

- **Real Rate:** The system will automatically calculate and allocate a *Real Rate* when you change the Working Rate.

- **Quality:** Click under each camera and select **1**, **2**, **3**, **4**, or **5**.

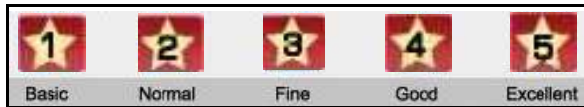

Figure 12.6 Set image quality: 1 basic ~ 5 excellent

- **Audio:** Click under each camera and select either **O** to enable audio or **X** to disable audio.

NOTE: Audio is only available on channels 1 and 2.

- **Resolution:** Click to set the resolution for all cameras—**640x240** or **640x480**.

To exit, right-click until you return to the main screen.

Schedule

4/8/16-channel

Set an hourly, daily, and/or weekly recording schedule.



Figure 12.7 Recording Schedule

The Recording Schedule is a grid featuring the days of the week and hours **0~23**.

 • **Working Hour**

 • **Non-working Hour**

Active recording is known as *Working Hour (yellow)* and non-recording is known as *Non-working Hour (green)*.

NOTE: As you make changes to the recording parameters, the storage calculator at the bottom of the menu displays the time remaining on the hard drive.

To set a recording schedule:

1. From the Record menu, click **Schedule**. The Recording Schedule grid opens.
2. Click an hour square (0~23) in each weekly row (Sun~Sat): active squares turn yellow, inactive turn green.
3. To save your settings, right-click or until you return to the main screen.

NOTE: Alarm or Motion Recording recording will not be affected by the recording schedule.

Format HDD

If you replace the pre-installed hard drive, the new drive *must* be formatted in order to function properly with the system.

ATTENTION: Formatting the HDD erases *all data* on the hard disk. *This step cannot be undone.*

To format the hard disk:

1. From the Main Menu, click . The Record menu opens.
2. Click **Format HDD**.
3. Click **Yes** to format the hard disk or click **No** to cancel.



Figure 12.8 Storage calculator

Please allow a few moments for formatting to take place and the system to reset.

Storage Calculator

A storage calculator shows the approximate maximum continuous recording time available on the hard drive based on your settings. Use the storage calculator to help maximize your hard drive space.



Figure 12.9 Storage calculator

NOTE: The estimation from the Storage Calculator is based *only* on Continuous Recording, not motion or alarm recording.

Alarm

4-channel

Configure alarm and motion detection settings.

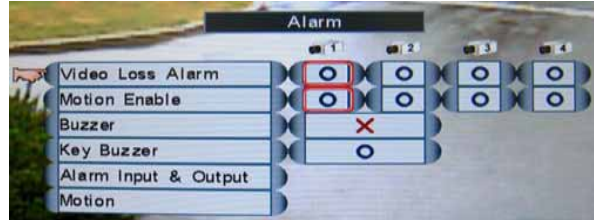



Figure 13.0 Alarm menu (4-channel)

To configure the alarm settings:

1. From the Main Menu, click . The Alarm menu opens.
2. Click and edit the following:
 - **Video Loss Alarm:** Click under each camera and select either **O** to enable the VLoss alarm, or **X** to disable it. If enabled, the system will sound an alarm whenever one of the connected channels incurs a loss of video.
 - **Motion Enable:** Click under each camera and select **O** to enable motion detection or select **X** to disable it. If enabled, the camera can record in specific recording parameters when it detects motion.

NOTE: With Motion Detection enabled, the text, "Motion" appears on-screen (full-screen and quad split-screen) whenever a motion event is triggered.
 - **Buzzer:** Select **O** to enable the system to beep when an alarm is triggered or motion is detected; select **X** to disable it.
 - **Key Buzzer:** Select **O** to enable the system beep when you click the mouse, press the buttons on the remote/front panel. Select **X** to disable the beep.

Alarm Input & Output Menu



Figure 13.0b Alarm Input & Output menu

- **Alarm-In Type:** Select **NO** (normally open) or **NC** (normally closed) for the alarm in device.
- **VLoss Response Time:** Select the time (in seconds) for the system to record prior to a triggered event: 0, 3, 5, 10, 30, 60, 120, 180, or Infinite.
- **Response Duration:** Select the time (in seconds) for the system to record after a triggered alarm or motion event: 1~255.

NOTE: The Response Duration also applies to the accompanying message and/or buzzer.

Alarm-In Setup Menu



Figure 13.0c Alarm-In Setup menu

To configure the Alarm-In Setup:

1. Click **Alarm-In Setup**.
2. Click on the desired alarm number (alarm 1~4) and assign it to the desired camera number.

Alarm-Out Setup Menu



Figure 13.0d Alarm-Out Setup menu

To configure the Alarm-Out Setup menu:

1. Click **Alarm-Out Setup**.

2. Click to assign an Event notification (Motion, VLoss, Alarm, HDD ON/OFF) to an Alarm-Out notification (Buzzer, Alarm Full-Screen, Label, Alarm Out 1).

- **Buzzer:** Select **0** to enable the system to beep when an alarm is triggered or motion is detected; select **X** to disable it.
- **Alarm Full Screen:** Select **0** to enable a full-screen display of the active alarm/motion channel; select **X** to disable it.
- **Label:** Select **0** to enable the system to display camera OSD when an alarm triggers.
- **Alarm Out 1:** Alarm 1 output.

3. To save your settings, right-click until you return to the main screen.

8/16-channel



Figure 13.1 Alarm menu (8/16-channel)

To configure the alarm settings:

- From the Main Menu, click . The Alarm menu opens.
- Click and edit the following:
 - **Video Loss Alarm:** Click under each camera and select either **0** to enable the VLoss alarm, or **X** to disable it. If enabled, the system will sound an alarm whenever one of the connected channels incurs a loss of video.
 - **Motion Enable:** Click under each camera and select **0** to enable motion detection or select **X** to disable it. If enabled, the camera can record in specific recording parameters when it detects motion.

NOTE: With Motion Detection enabled, the text, "Motion" appears on-screen (full-screen and quad split-screen) whenever a motion event is triggered.
 - **Buzzer:** Select **0** to enable the system to beep when an alarm is triggered or motion is detected; select **X** to disable it.
 - **Key Buzzer:** Select **0** to enable the system beep when you click the mouse,

press the buttons on the remote/front panel. Select **X** to disable the beep.

- **Alarm Input & Output:** Click to open the Alarm Input & Output menu.

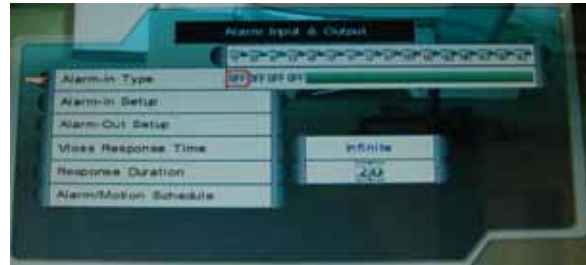

Figure 13.2 Alarm Input & Output menu

- **Alarm-In Type:** Select **OFF/ NO (normally open) / NC (normally closed)** to select alarm type.
- **Alarm-In Setup:** Click to open the Alarm-In Setup menu. Click to assign channels to up to four alarms.



Figure 13.3 Alarm-In Setup menu (8/16-channel only)

- **Alarm-Out Setup:** Click to open the Alarm-Out Setup menu. Click to assign an Event notification (Motion, VLoss, Alarm) to an Alarm-Out notification (Buzzer, Full-Screen, Label, Alarm Out 1).



Figure 13.4 Alarm-Out Setup menu

- **VLoss Response Time:** Select the time (in seconds) for the system to record prior to a triggered event: **0, 3, 5, 10, 30, 60, 120, 180, or Infinite**

- **Response Duration:** Select the time (in seconds) for the system to record after a triggered alarm or motion event: **1~255**.

NOTE: The Response Duration also applies to the accompanying message and/or buzzer.

- **Alarm/Motion Schedule:** Click to enable/disable the Alarm/Motion Schedule for each day of the week/ hours 0-23.



 • **Enabled** (yellow)  • **Disabled** (green)

Figure 13.5 Alarm/Motion Schedule [8/16-channel *only*]

- Select the size of the selection cursor by clicking: **1x1** , **1x13** , **3x5** , **3x13** , **5x9** , **7x13**
- To save your settings, right-click until you return to the main screen.

Motion

4/8/16-channel

Set the motion detection cells and sensitivity for each camera.

To configure motion detection:

1. From the Alarm menu, click **Motion Enable**. The text, "Motion" will appear on-screen when motion is detected on the respective camera.
2. Choose a camera for motion detection and select **0**.

3. Click **Motion**. Select the camera you want to configure motion detection. The motion grid appears for the selected camera.



Figure 13.6 Select the camera for motion detection (4-channel)

4. Click within the grid to enable/disable individual motion cells. Enabled cells are light green; disabled cells are clear.



Figure 13.7 Select cells and adjust sensitivity

5. Click the **Sensitivity bar** at the bottom of the screen. Scroll up/down to increase/decrease the sensitivity for the motion cells from **0~100**. The higher the number, the greater the sensitivity.

NOTE: Sensitivity applies to all cells. If the Sensitivity bar is not visible, click .

6. Click  to enable/disable the entire grid.
7. To save your settings, right-click until you return to the main screen.

Backup

Set start and stop times for recorded video data you wish to copy to a connected USB flash drive (not included).

NOTE: The system supports most brands of USB flash drives from 128 MB ~ 8 GB.

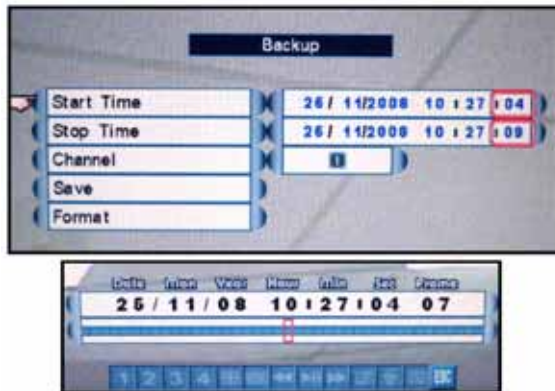

Figure 14.0 Backup menu

Formatting the USB Drive

Prior to backing up data, you must first format the USB flash drive so it will function properly with the system.

ATTENTION: Formatting erases *all data* on the USB flash drive. This step *cannot* be undone.

To format the USB drive:

1. Connect a USB flash drive to the USB port on the front panel on the system.

NOTE: Do not connect a USB flash drive to the USB port on the rear panel. Only the port on the front panel has been designed for backup data transfer.

2. From the Main Menu, click . The Backup menu opens.
3. Click **Format**.

4. Click **Yes** to format the hard disk or click **No** to cancel.



Figure 14.1 Confirm formatting

Please allow a few moments for formatting to take place and the system to reset.

To backup data:

1. Connect a formatted USB flash drive to the USB port on the front panel.

NOTE: Do not connect a USB flash drive to the USB port on the rear panel. Only the port on the front panel has been designed for backup data transfer.

2. From the Main Menu, click . The Backup menu opens.
3. Click **Start Time**, and select the date, month, year, and time to begin the backup. Event Markers will appear in the Time Bar as you scroll through the date and time.
4. Click **Stop Time**, and select the date, month, year, and time to begin the backup.



NOTE: Event Markers will appear in the Time Bar as you set through the Start and Stop times.

5. Click **Select Channel**, and select a channel for backup.
6. Click **Save**. Backup begins—the on-screen counter displays the progress of the transfer based on the selected start and stop times.
7. To cancel Backup, right-click until you return to the main screen. Please allow a few moments for the system to exit.

NOTE: Backup may take several moments depending on the size of data being transferred.

Confirming Backup

To verify that the file has been properly backed up:

1. Click  to open Event List.
2. Click  from the Smart Search event filter.
3. Select the file and click . The backup file should begin playing.
4. To exit, right-click until you return to the main screen.

Backup File Information

Backup files are saved as MOV files. These files can be played on the system using Event List or on your PC using QuickTime Player. See “Event List” on page 21.

Backup files are labeled according to the following naming convention:

ch_##YYYYMMDDhhmmss.mov:

Filename	Definition
ch_##	Channel number (1~16)
YYYY	Year
MM	Month
DD	Day
hh	Hour
mm	Minute
ss	Second

Playing Saved Video

View your saved backup video files using QuickTime Player.

To playback MOV files:

1. On your PC, open the folder where you saved the MOV file (by default, C:\). By default, converted files use the following naming convention: **bv3.mov**
2. Double-click the file to open it in QuickTime Player.

Setting Quicktime as a default media player

It is recommended to set Quicktime as your default media player. This allows you to double-click on a backed up video file, and have the file play automatically.

To set Quicktime as your default player:

1. Right-click on the backed up video file you wish to view.
2. Move the cursor to **Open With**.
3. Click on **Choose Default Program**.
4. Under Recommended Programs, select QuickTime Player and then click **OK**.

NOTE: For the latest version of QuickTime, go to www.apple.com/quicktime/download/

You can back up video with audio in channels 1 and 2 only. Be sure to enable audio in the Recording menu.

LAN

Configure network settings.

From the Main Menu, click . The LAN menu opens.

NOTE: Some networking knowledge is required when adjusting options in the LAN menu.



Figure 15.0 LAN menu

To configure network settings:

1. Select the following, and use the scroll-wheel to change values:
 - IP
 - Mask
 - Gateway
 - DNS Server
 - DHCP Enable
 - HTTP Port
 - Easy Connect
2. To save your settings, right-click until you return to the main screen.

NOTE: DHCP allows you to quickly connect to your network by obtaining an IP address from the router. After the initial setup, we recommend that you disable DHCP and change the last set of numbers in the IP address between 2-99. For example, if your IP address is 192.168.0.107, change the last digits to 90 (i.e. 192.168.0.90). This ensures that port forwarding will not change in the event of power failure or resetting of your network.

NOTE: For added security, we strongly recommend changing HTTP port 80 on the system to *any desired port* not blocked by your Internet service provider (ISP). For details on changing ports on your system, see “Changing Ports On Your System” on page 42.

Easy Connect

Use the Easy Connect menu to enable Easy Connect, and view the Easy Connect log.

For details on connecting to your system remotely using Yoics, see “Remote Viewing Using Easy Connect” on page 61.



Figure 15.1 : Easy Connect menu.

To enable Easy Connect:

- Select Yoics Enable, and use the scroll wheel to select **O** to enable Easy Connect; **X** to disable Easy Connect.

To reset Yoics:

- Click **Reset Yoics**.

NOTE: It may take several minutes for the changes to take effect. Restarting Yoics is used for troubleshooting only.

To view the Yoics Log:

- Click **Log File**.



Figure 15.2 : Log File window.

LAN Password

Use the LAN Password to control Remote Viewing access for Guest, User, and Administrator profiles. The LAN password is required if using the built-in browser-based remote client software.



Figure 15.3 LAN Passwords

To change LAN passwords:

1. Select **LAN Password** and use the Password Wheel to login as the administrator (by default - **4 channel**: ID: 2; password: 2222/ **8/16 channel**: ID: 3; password 3333).
2. Only the administrator can edit and manage LAN passwords.
3. Select the following, and use the Password Wheel to change the LAN user ID and password:
 - **Guest Password**: Lowest level network user, with access to remote live viewing only. By default, **ID 7; pass: 1111**.
 - **User Password**: Normal level network user, with access to remote live viewing and playback only. By default, **ID 8; pass: 2222**.
 - **Administrator Password**: Highest level user, with access to remote live viewing, playback, and permissions to change network configurations. By default, **ID 9; pass: 3333**
4. To save your settings, right-click until you return to the main screen.

Upgrading Firmware

Firmware upgrades can provide improved functionality to your system. You can download these free upgrades from www.lorexttechnology.com.

Prior to upgrading your system's firmware, you must first format the USB flash drive so it will function properly with the system.

ATTENTION: Formatting erases *all data* on the USB flash drive. This step *cannot* be undone.

To upgrade firmware:

1. Connect a USB flash drive to the USB port on the front panel of the DVR and format (see "Formatting the USB Drive" on page 38.) Once formatting is complete, remove the USB flash drive and connect it to a USB port on your computer.

NOTE: The system creates two folders on your USB drive: *Picture* and *Movie*.
2. In your web browser, visit your DVR manufacturer's website and download the free firmware upgrade.
3. Copy the firmware file to the connected USB flash drive—*do not* place the file in either the Picture or Movie folder. Once the file transfer is complete, remove the USB flash drive from your computer.
4. Disconnect the power cable to power off your DVR and connect the USB flash drive. Reconnect the power cable.
5. The system will detect the USB drive and new firmware and begin the upgrade process. The system will prompt you when the upgrade is complete.
6. Remove the USB flash drive from your DVR and power off your system.
7. Power on the system. The system is now upgraded with the new firmware.

CHANGING PORTS ON YOUR SYSTEM

For added security, we strongly recommend changing HTTP port 80 on the system to *any desired port*—the port must not be blocked by your Internet service provider (ISP).

NOTE: Please contact your ISP for complete information on available ports in your area.

Prior to changing ports on your system, you must connect your system to your network using the included Ethernet cable.

If you change the default port on the system from 80 to a different value, you **MUST** enter `http://` and the port number after the IP address.



For example, if you change your port number from 80 to 85, you **MUST** enter port 85 after the IP address, i.e. `http://192.168.5.120:85`.

There is a semi-colon after the IP address, followed by the port number.

Example

Let's say you want to change the HTTP port on your system from 80 to *85*.

To change the port number:

1. Click  to open the Main Menu and then click . The LAN menu opens.
2. From the LAN menu, select **HTTP Port**.
3. Use the scroll-wheel (or press  on the remote control) to change the port number to **85**.

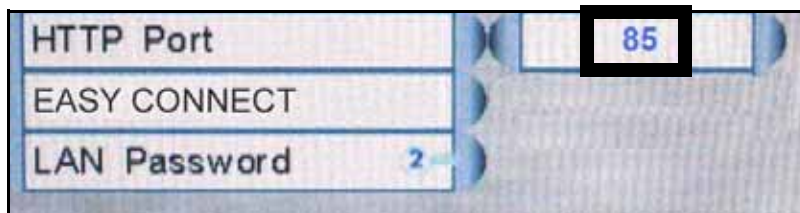



Figure 15.4 Change the HTTP port

4. Right-click to exit and save your settings (or press the **ESC button** on the remote control).
5. Disconnect the power cable from the rear panel of the system. Let the system power-down for 15~20 seconds and then reconnect the power cable.
6. To confirm that the new port number is saved on your system, the  button twice on the remote control to view the System Information.

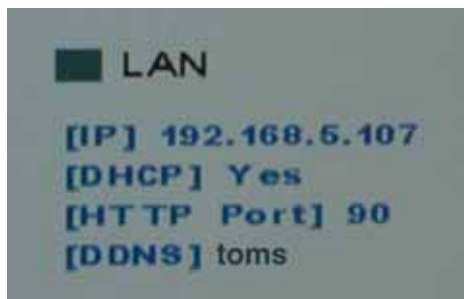

Figure 15.5 Confirm the new HTTP port

You must now include the new HTTP port number in the URL when logging in to your system with Internet Explorer.

NOTE: Requires Internet Explorer 6 or later.

Local Viewing:

To log in using the new port number:

1. Open Internet Explorer.
2. In the address bar, enter **http://**, then the **IP address** of your system immediately followed by **:85** (no spaces). For example, `http://192.168.1.89:85`



Figure 15.4 Enter :85 at the end of the IP address

3. Enter your *LAN ID* and *password* to log in to your system using DVR Netviewer.

A screenshot of a login form titled "LOGIN PASSWORD" in a purple header. The form has two input fields: "ID:" with the value "9" and "Password:" with four black dots. Below the fields is a blue "LOGIN" button.

Figure 15.6 Login with your LAN ID and password

Remote Viewing:

You should now be able to access your system from your local network. Prior to using remote viewing, you must log in to your system and enter the DDNS information from your Lorex DDNS confirmation email.

NOTE: We strongly recommend registering for Lorex’s free DDNS service prior to using remote viewing. For details, see “Setting Up DDNS” on page 76.

ATTENTION: For remote viewing, the HTTP port of your system *MUST be port forwarded on your router*—in this example, port 85. Each router is different, so port forwarding settings vary by model. Please refer to the Lorex Port Forwarding Guide (www.lorexctv.com/support and then click Consumer Guides) for help on port forwarding your router. If your router is not listed, please refer to your router’s manual or contact your router’s manufacturer for assistance.

To edit DDNS settings:

1. From a PC on your **local network**, open Internet Explorer.
2. In the address bar, enter **http://**, then the **IP address** of your system, followed by a semi-colon, then the port number (**i.e. :85**) . For example, `http://192.168.1.89:85`
3. Enter your **LAN ID** and **password** to log in to your system.
4. Click the **Setup button** and then click **Network**.
5. Click **DDNS**. Enter your DDNS information from the confirmation email and click **Submit**. For complete details on entering your DDNS information, see “Enabling DDNS on your system” on page 77.
6. Reset your system by disconnecting the power cable from the rear panel of the system. Let the system power down for 15~20 seconds and then reconnect the power cable.
7. To confirm that the DDNS information is saved on your system, press the  button twice on the remote control to view the System Information.

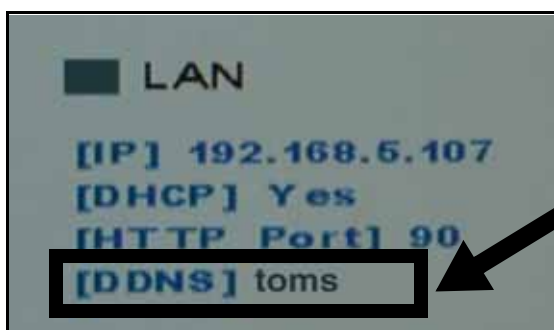

NOTE: The system has a 4-character *displaylimit* for the DDNS subdomain. Please note however, that *the complete subdomain* (i.e. tomsmith) is saved by the system.

Figure 15.7 Your DDNS sub-domain should appear in System Information

8. If you have not already done so, use the Auto Port Forwarding Software (included on CD) to port forward port 85 on your router or;
 - Manually port forward your router. Each router is different, so port forwarding settings vary by model. Please refer to the Lorex Port Forwarding Guide (www.lorexctv.com/support and then click Consumer Guides) for help on port forwarding your router. If your router is not

listed, please refer to your router's manual or contact your router's manufacturer for assistance.

Now that you have configured your DDNS settings, you should be able to log in to your system from a remote PC (i.e. a PC not on your local network).

NOTE: *4/8/16-channel:* The PC used for remote viewing requires Internet Explorer 6 or later.

To log in using DDNS:

1. Using a remote PC, open Internet Explorer.
2. In the address bar, enter your **DDNS address** immediately followed by **:85** (no spaces).

NOTE: Obtain your DDNS address from your confirmation email.



Figure 15.7 Enter :85 at the end of the DDNS URL

3. Enter your **LAN ID** and **password** to log in to your system.

A screenshot of a web-based login page. At the top, there is a purple header with the text "LOGIN PASSWORD" in white. Below the header, there are two input fields. The first is labeled "ID:" and contains the number "9". The second is labeled "Password:" and contains four black dots. Below these fields is a blue button with the text "LOGIN" in white.

Figure 15.8 Login with your LAN ID and password

If you are having problems connecting using DDNS, check that you have port forwarded port 80 on your router.

REMOTE ACCESS: DVR NETVIEWER

DVR Netviewer is the built-in browser-based remote surveillance software that allows you to access your system from any PC with an Internet connection.



Figure 16.0 DVR Netviewer Main Screen (8/16-channel)



Figure 16.1 Main screen (4-channel)

System Requirements

Prior to using DVR Netviewer, make sure your PC meets or exceeds the following system requirements:

Description	Requirement
CPU	Intel Pentium® 4 3.0ghz or above (PC) / Intel Pentium Core Duo, 1.66 Ghz or above (Mac)
Operating System	Windows XP®/Vista®/ 7® Apple OSX 10.5 or above
Memory	128 MB RAM
Video	16 MB of video memory
Network (LAN)	10/100 BaseT Network
Network (WAN)	384 Kbps upstream* *High-speed Internet service is recommended when using DVR Netviewer.
Browser	Internet Explorer® 6 (or later); Mozilla Firefox is also supported but you need to install the IE Tab plug-in (http://addons.mozilla.org) / Safari 4.0 and above
Media Player	QuickTime Player 7 or later—visit www.apple.com to download the latest version

Netviewer: Basic Layout

4 Channel



Figure 17.0: Four channel Netviewer.

16 Channel



Figure 17.1: Sixteen channel Netviewer.

Network User Profiles

In order to login to DVR Netviewer, you need a network user ID and password. Use the following default network user IDs and password to login to DVR Netviewer:

Remote/LAN Viewing

4/ 8/ 16 Channel

LEVEL	ID	PASSWORD
GUEST	7	1111
USER	8	2222
ADMIN	9	3333

DVR Netviewer Main Screen

4-channel

Upon login, the DVR Netviewer main screen appears in your browser. By default, DVR Netviewer opens in Live Viewing mode.



Figure 19.0 DVR Netviewer main screen

1. **Display screen:** Displays channels in single channel full-screen, or all channels in quad split-screen.
2. **Date/Time:** Present date and time on the networked system.
3. **Modes:**
 - *LIVE*: Click to view live, streaming video; view single channels in full-screen, or view all channels in quad split-screen.
 - *PLAYBACK*: Click to view recorded video from the system. Select channel and enter date and time; playback controls appear when Playback mode selected.
 - *BACKUP*: Click to save recorded video data to your PC.
 - *SETUP*: Click to open the Setup menu. **(Not available on Safari (Mac)).**
4. **Views:** Click to view in Quad mode (4-channel).
5. **Channels:** Click to view channels in full-screen.

NOTE: PTZ function is not available in Netviewer.

8/16-channel



Figure 19.1 DVR Netviewer main screen (16-channel shown)

1. **Display screen:** Displays channels in single channel full-screen, or all channels in quad split-screen.
2. **Date/Time:** Present date and time on the networked system.
3. **Modes:**
 - *LIVE*: Click to view live, streaming video; view single channels in full-screen, or view all channels in quad split-screen.
 - *PLAYBACK*: Click to view recorded video from the system. Select channel and enter date and time; playback controls appear when Playback mode selected.
 - *BACKUP*: Click to save recorded video data to your PC.
 - *SETUP*: Click to open the Setup menu. **(Not available on Mac)**
4. **Views:** Click to view in Quad (1-4, 5-8, 9-12, 13-16) and 16-split.
5. **Channels:** Click to view channels in full-screen.

NOTE: PTZ function is not available on Netviewer.





Live Viewing

By default, DVR Netviewer launches in Live Viewing mode.



Figure 20.0 Live Viewing controls (4-channel shown)

To use Live Viewing:

1. Click .
2. Click , , , , to view in Quad or 16-split.
3. Click the Channel buttons to view channels in full-screen.

Playback

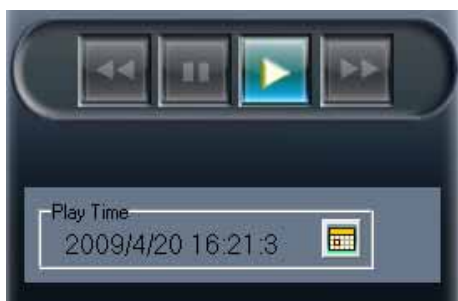







Figure 21.1 Playback controls .

NOTE: Depending on your network connection, please allow a few moments for the system to switch to playback mode.

To use remote playback:

1. Click .
2. Click the **Channel buttons** to select the channel you want to view.

3. Click  to open a pop-up calendar to select the date and time.
4. Click , , ,  to control playback.

Using the Pop-Up Calendar

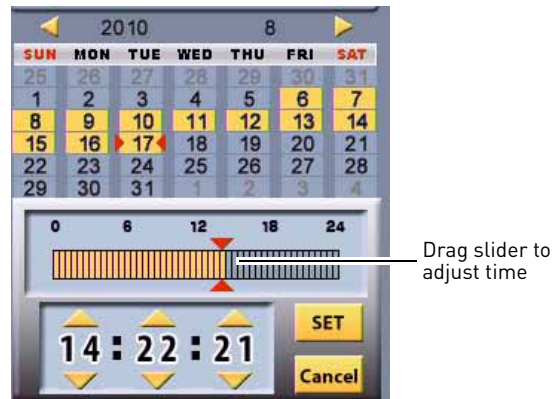









Figure 21.2 Pop-Up Calendar PC and Mac version.

To use the pop-up calendar:

1. Click   to change the month.
2. Select a date.
3. Click   to set the time.
 - OR: Drag the slider to adjust time in 30 minute increments.
4. Click **SET**. The pop-up calendar closes.
5. Click , , ,  to control playback.

Backup

Use Backup to copy recorded video data from your DVR to your PC or Mac.

- PC users must use Internet Explorer only
- Mac users must use Safari only

NOTE: Only the system administrator (by default, *ID 9, password 9999*) may use the Backup function of DVR Netviewer.

NOTE: You may be prompted to install the ActiveX plug-in for Backup to function properly.

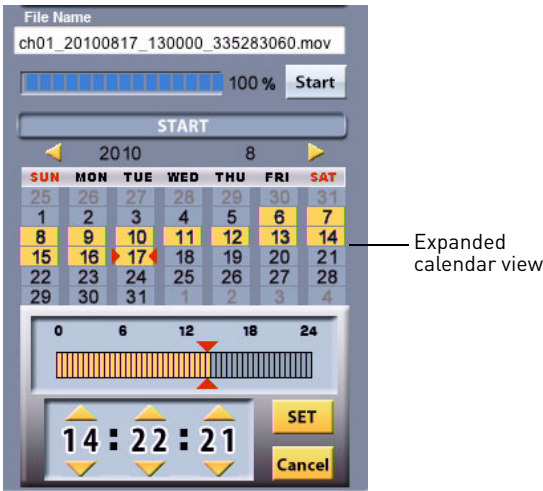

Figure 22.0 Backup controls .

- When prompted, click the bar to install ACTIVE X to your browser. DVR Netviewer will reset. You may need to log in again with your user ID and password.

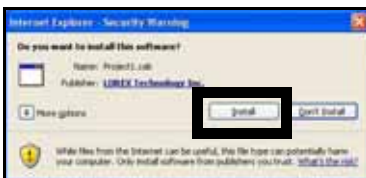





Figure 22.1 Install the Project1 . cab file

NOTE: You may need to log back into your system via DVR Netviewer after the Backup process.

To use Backup:

1. Click the  (**BACKUP**) button.
2. Click the **Channel buttons** to select the channel you want to back up.

3. Under Start Time, click  to open the pop-up calendar and enter a date and time. Click the **SET** button.
4. Under Stop Time, click  to open the pop-up calendar and enter a date and time. Click the **SET** button.
5. Click **Start** to begin backup. The file is saved to C:\DVR_Backup (PC) , Macintosh HD → DVR_Backup (Mac)

NOTE: Backup files carry the file extension **.mov**; QuickTime Player is required to view MOV files. Windows Media player can also play .mov files in Windows 7.

OR

6. Under File, click the text field to select the save location and file name for the backup file.
7. Click **Start**. File backup begins. Depending on your connection and size of the file, this could take several moments.



Figure 22.2 Backup progress (8 channel shown)

- By default, the backed up videos are stored in a folder named **DVR_Backup**.
- Default save directory for PC users: (C:\DVR_Backup)
- Default save directory for Mac users: (Macintosh HD → DVR_Backup)

NOTE: PC users can backup video with audio (audio capable cameras required, not included). Mac users can only back up video, with no audio.

Setup

Use Setup to configure your network settings and video streaming options.

NOTE: All users (by default, *IDs 7, 8, and 9*) have access to the Setup menu; only the system administrator (by default, *ID 9*) may configure PPPoE and DDNS settings.

To open the Setup menu:

- From the main screen, click the  (**Setup button**). By default, the System Status screen opens.



Figure 23.0 System Status in Setup menu.

Bitrate

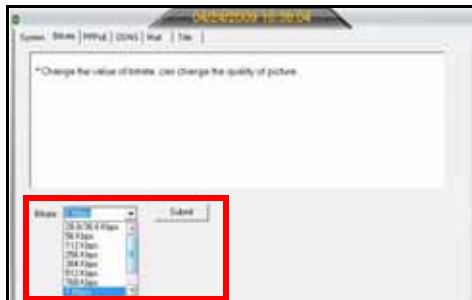

Figure 23.1 System Status in Setup menu (8/16-channel)

To change Bitrate speed:

1. Click the **Bitrate tab**.
2. Under Bitrate, select a **bitrate speed**. The higher the bitrate, the better the quality of the video stream. Adjust the bitrate speed to best suit your connection.
3. Click **Apply** to save your settings to the system.

PPPoE

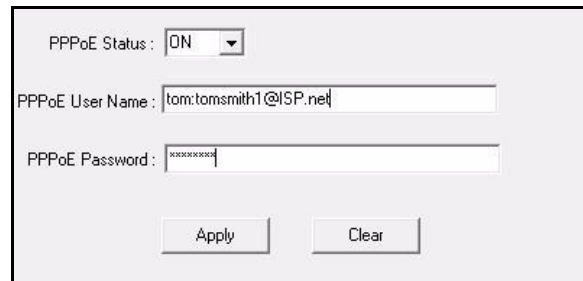

Figure 23.2 PPPoE menu (8/16-channel)

To change PPPoE settings:

1. Click the **PPPoE tab**.
2. Under the PPPoE Status, select **ON**.
3. In the corresponding text fields, enter your **PPPoE Username** and **password**.
4. Click **Apply** to save your settings.

DDNS

Lorex provides a free DDNS service for use with your DVR. A DDNS account allows you to set up a web site address that points back to your Local Network.

ATTENTION: You *MUST* enter your DDNS information *LOCALLY* before attempting remote access.



Figure 23.3 DDNS menu.

Visit <http://lorexddns.net> to register for Lorex's free DDNS service. For more details on setting up a free Lorex DDNS account, see "Setting Up DDNS" on page 76.

NOTE: You must register for Lorex's free DDNS service prior to configuring DDNS settings.

Figure 23.4 Enter only the first portion of your domain name .

To change DDNS settings:

1. Click the **DDNS tab**.
2. Under DDNS Select, click the drop-down menu and select **http://lorexddns.net**
3. In the corresponding text fields, enter your **DDNS username** and **password**.

NOTE: Obtain this information from the confirmation email after registering for the free Lorex DDNS service.

4. Under DDNS Domain Name, enter only the **first portion of your DDNS domain** from the confirmation email. For example, if your domain name is tomsmith.lorexddns.net, you only need to enter *tomsmith* in the text field.
5. Click **Apply** to save your settings or click **Clear** to exit without saving.
6. To ensure your DDNS settings are saved on your system, disconnect the power cable from the rear panel of your system. Allow the system to power down for 15~20 seconds. Reconnect the power cable.

NOTE: Please allow 10~15 minutes for the DDNS servers to update with your new DDNS address. This is normal for the DDNS system.

System Status

By default, the Setup menu opens to the System Status screen. However, you view this screen at any time when navigating the Setup menu.



Figure 23.5 System Status (8/16-channel).

To view system status:

- Click the **System tab**. The System Status screen appears.

NOTE: You cannot edit the IP address or port number.

Resuming Live Viewing

To return to DVR Netviewer main screen:

- From the Setup menu, click  .

Mail

Configure email notification for triggered events on your system.



Figure 23.6 Default email notification setup (8/16-channel only)

NOTE: By default, Mail Notification is designed to work with Lorex DDNS. You must first register with Lorex DDNS for email notification to work. However, you can also use your own SMTP server.

To configure email notification:

1. Under Send Mail Status, select **Default**.
2. In the From Your Email field, enter the **sender's email address**.
3. In the **Interval** drop-down menu, select the duration the system will pause sending notifications before sending out a new e-mail alert.
4. In the Send To Email fields, enter the **recipient's email address**.

NOTE: You *must* enter a sender and recipient email address for mail notification to work.

5. *Optional:* Enter a subject for the notification and a location (of the DVR) in the respective fields.
6. Click **Apply** to save your settings or click **Clear** to exit without saving.
7. Click **Test Email** to send a test notification. Click **OK** to close the confirmation window.

NOTE: If you have made a mistake with either email addresses, you will not receive the test notification.

NOTE: If you want to use your own SMTP server, select **ON** from the Send Mail Status drop-down menu. Enter the address of your SMTP Server, port, user name, and password. Select the box to log on using secure authentication. Enter the sender's email address and recipient's email address. Click **Apply** to save your settings and Test Mail to test the notification.

NOTE: 8/16 channel models send e-mail notifications with a screen capture. 4 channel models send text notifications only.

Title

Edit the camera names/titles on your system.



Figure 23.7 Camera title setup (8/16-channel only—16-channel shown)

To edit camera names/titles:

1. Click the **Title tab**.
2. In the Channel fields, enter the **new name/title** for the camera. For example, *Parking Lot 1*, *Front Door*, etc.
3. *Optional:* Click **Font Option** to select the font and font style.

NOTE: You cannot change color, underline, or strike through options.

4. *Optional:* Under Font Size, click the drop-down menu and select **X-Large**, **Large**, **Medium**, **Small**, or **X-Small**. You can also drag the slider to adjust the font size.
5. *Optional:* Click the drop-down menu below the font options to select the language for the camera titles.
6. Click **Save File** to save your camera title configuration to your PC. Files are saved as MOV files.

NOTE: Click **Load file** to open the saved configuration file on your PC.

7. Click **Apply** to save the new title to your system.
8. Refresh your screen by changing the display mode (single, quad, split-screen) to see the titles.

SETTING UP LOCAL AND REMOTE VIEWING

You can connect the system to a network for local or remote viewing. Once connected, you can access your system locally or remotely using the DVR Netviewer with Internet Explorer™ (PC) or Safari™ (Mac™).

NOTE: Experience with routers and networking are recommended if configuring the network functions of the system.

What do I need?

- Edge DVR System
- PC with Internet Explorer 6 or later OR Intel-based Mac™ with OSX and Safari web browser (version 4 or later)
- Router and high speed internet (not included)

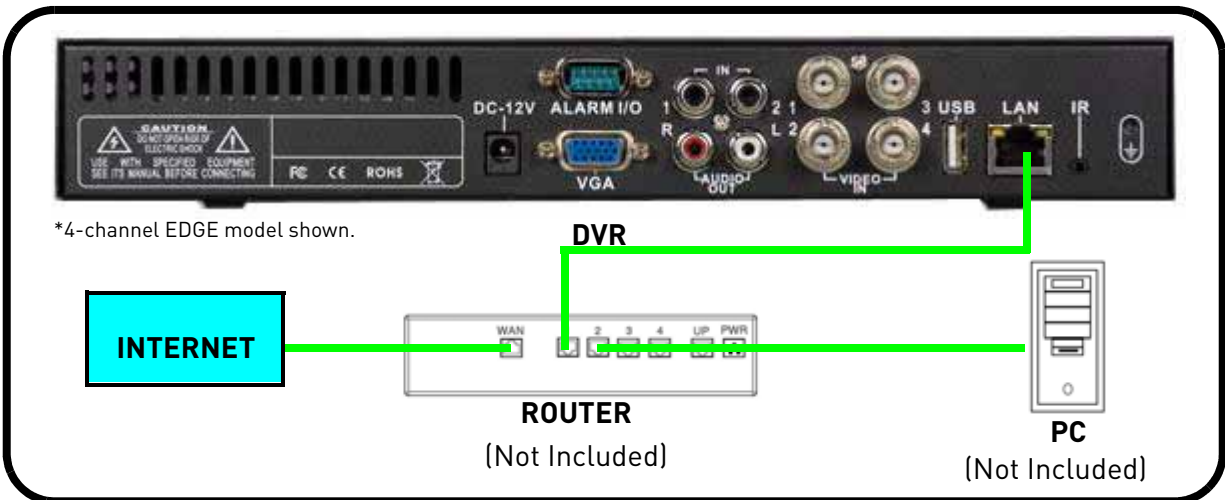

Figure 24.0 Setting up remote and local viewing.

Local Vs Remote Viewing

Local viewing is useful if you wish to monitor your system within an internal network (i.e. inside your home). Connecting locally usually results in smoother video because you are connecting to your DVR locally, as opposed to remotely. An Internet connection is not required for local viewing.

Remote viewing allows you to connect to your system from anywhere that has Internet access. An Internet connection is required for remote viewing.

Viewing your system through a Local Area Network

To connect to a network:

1. Power off your system by disconnecting the power cable from the rear panel.
2. Connect an Ethernet cable (included) to the LAN port on the rear panel of the system. Connect the other end of the Ethernet cable to an empty LAN port (usually numbered 1~4) on your router.

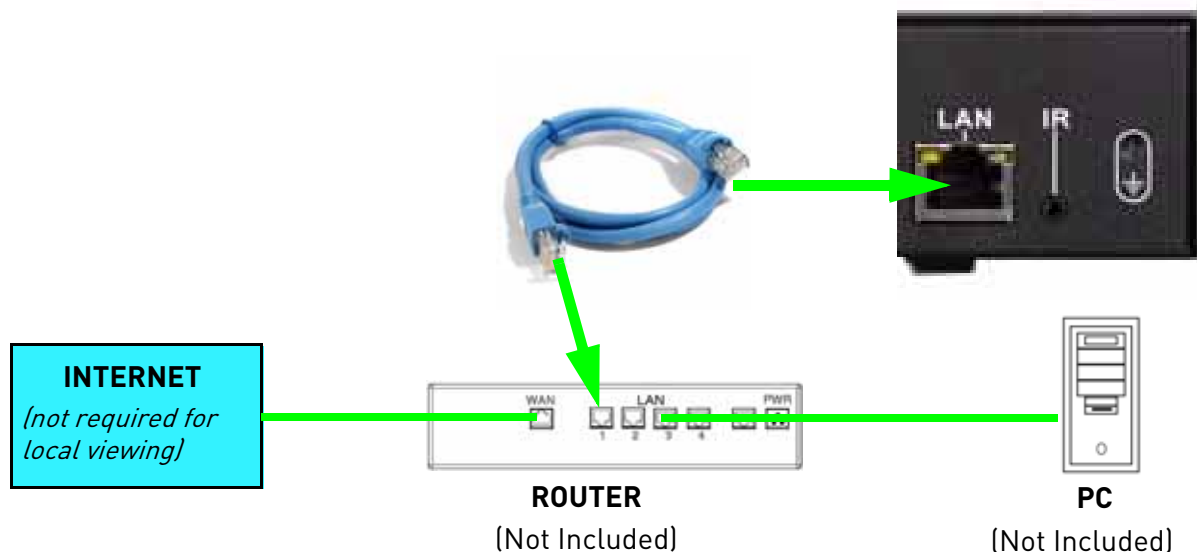

Figure 24.1 Downloading the Safari plug-in.

3. Reconnect the power cable to power the system back on.
4. Locate your system's IP address and port number.

Finding your IP address and port number

NOTE: Make sure you have connected the DVR to your local or wide area network via the LAN port on the rear panel of the system.

To find your IP and MAC addresses:



1. Press the  button twice on the remote control, or front control panel (EDGE+ only)
OR
2. From the Main Menu, click , and then click **Information**. Your IP address, MAC address, and Port number are under LAN.



Figure 24.2 System information.

3. To exit, right-click or click "C" in the menu bar until you return to the main screen.

Connecting to your system

Once you have your system's IP and HTTP Port number, you can view your system locally through the same local network.

To view your system locally:

1. Open Internet Explorer or Safari (Mac users)
2. Enter **http://**, then your **system's IP address**, followed by a **semi-colon**, followed by the **HTTP port number**. For example, enter **http://192.168.11.89:80** into the web browser.
3. Enter the system's login and password information, and then click **Login**.

Example

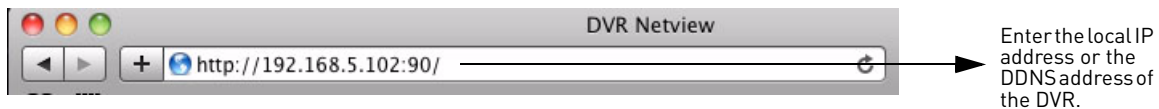

Figure 24.3 Entering the DVR's IP address into the address bar.

NOTE: This method only works for LOCAL VIEWING ONLY. If you wish to access your system from a remote location, you must setup Easy Connect, or enable DDNS.

Connecting to your system on Internet Explorer (PC):

1. Open Internet Explorer.
2. In the address bar, enter the IP address of your system. (Press the Enter button on the remote twice to open the system information window.
3. In the ID and password fields, enter your **LAN user ID** and **password** and click **LOGIN**. If you enter an incorrect user ID or password the login page will refresh and the text fields will clear.

 A screenshot of a login screen with a purple header that says "LOGIN PASSWORD". Below the header are two input fields: "ID:" with the value "9" and "Password:" with four black dots. At the bottom center is a blue button labeled "LOGIN".

Figure 24.4 Login screen.

4. You must install the ActiveX[®] plug-in for DVR Netviewer to function. Click the attention bar at the top of the main page and select **Install ActiveX Control**. DVR Netviewer will reset.



Figure 24.5 Click the ActiveX attention bar

5. Log in with your **LAN user name** and **password**.
6. From the security window, click **Install**. DVR Netviewer launches.

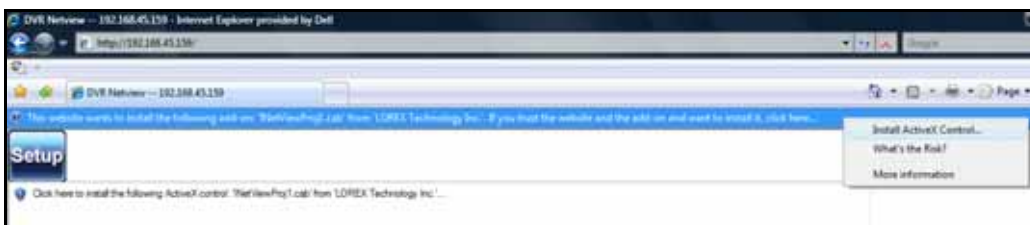

Figure 24.6 Select Install ActiveX Control

NOTE: ActiveX must also be installed on 4-channel systems when using remote backup. For more details, see “Backup” on page 51.

Connecting to the system using Safari (Mac)

Safari requires a plug-in before Net Viewer can run.

To install the Net Viewer plug-in:

1. Connect to your system locally or remotely.



Figure 24.7 Login window (Mac).

2. Enter the DVR's user name and password.

- A plug-in window opens.

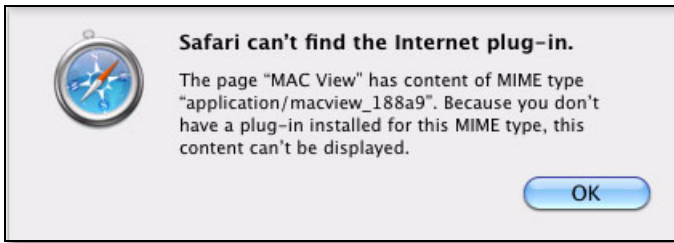

Figure 24.8 Safari plug-in prompt.

3. Click **OK** to continue.
4. Click the **Safari Plug-In** Download link near the bottom of the window.

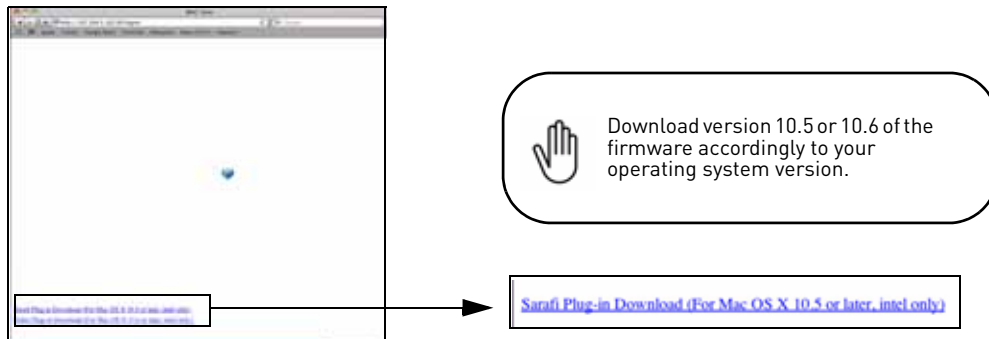

Figure 24.9 Safari plug-in link.

NOTE: Net Viewer requires an Intel based Mac.

5. Double-click the MacView plug-in from the download list to begin installation.

NOTE: Plug-in may automatically run for OSX 10.6 users.

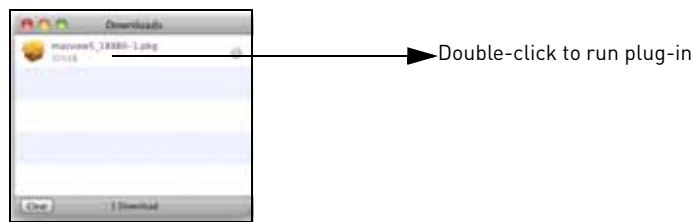

Figure 24.10 Downloading the plug-in.

6. Follow the on-screen instructions to install the plug-in.

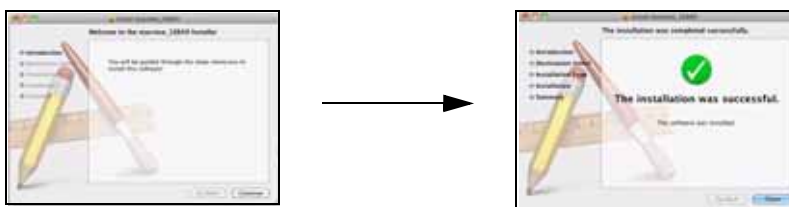

Figure 24.10 Plug-in installation.

7. Restart Safari and re-login to Net Viewer to begin viewing.

SETTING UP REMOTE CONNECTIVITY

Your system is capable of remote connectivity. You can connect to your system through:

- A remote computer via web browser (Internet Explorer & Safari)
- A Mobile Device (iPhone™, Blackberry™, Windows Mobile™)

Remote Connectivity Options

Option 1: Lorex Easy Connect Remote Viewer

- Lorex Easy Connect supports remote viewing on a computer web browser only.
- Lorex Easy Connect allows you to connect to your system remotely without router port forwarding.

Steps required:

1. Create an Easy Connect account.
2. Enable Easy Connect on your system.
 - For details, see “Remote Viewing Using Easy Connect” on page 61.

Option 2: Advanced Monitoring using DDNS

- DDNS allows you to connect to your system remotely using a computer or mobile device.
- Port forwarding is required.

Steps Required:

1. Port forward port **80** to your router using one of the following:
 - The Auto Port Forwarding Wizard (included link on software CD).
 - Manually port forwarding the required port to your router (consult router owner’s manual).
2. Create a Lorex DDNS account.
3. Enable DDNS on your system.
 - For details on the Auto Port Forwarding Wizard, see “Lorex Auto Port Forwarding Wizard” on page 69.
 - For details on creating a DDNS account, see “Setting Up DDNS” on page 76.
 - For details on enabling DDNS on your system, see “Enabling DDNS on your system” on page 77.

REMOTE VIEWING USING EASY CONNECT

Yoics is an online service that allows you to connect and manage your Lorex devices online without router configuration. Register with Yoics to remotely view your cameras on your DVR anywhere in the world.

Before You Get Started

While Yoics is the most advanced networking solution available in the market, it may not address all circumstances.

Lorex is providing the Yoics service free of charge to the customer to ease the network configuration process. Yoics is designed for Instant Remote Viewing. Yoics times out after 15-30 minutes to conserve your bandwidth.

Depending on your network bandwidth, the remote viewing speed measured in Frames Per Second (FPS) may vary and may be as low as 1-2 FPS.

Intended Use

Yoics Easy Connect is designed for homes and small businesses that do not have a corporate network infrastructure.

If for any reason the Yoics Easy Connect solution is not compatible with your environment, please refer to the instruction manual for internet remote viewing using the remote viewing software.

Software Compatibility

System Requirements:

- Microsoft Windows XP, Vista, Windows 7 operating systems
- Internet Explorer 6 or later **only**

NOTE: Firefox, Safari and browsers other than Internet Explorer are not supported.

Enabling Easy Connect

Easy connect is included in firmware version **7.21.02_18717** (4-channel) or **1.30.09_18712**

(8/16-channel) **or above**. To check your firmware version, from the Main Menu, click , and then click **Information**. Your firmware version is listed under **S/W**.

You may need to upgrade your system to the latest firmware to enable Easy Connect. Then, you must create a Yoics account. Download the latest firmware from www.lorextechnology.com.

Upgrading The Firmware

Prep the USB Flash Drive

NOTE: You must format the USB flash drive using the DVR. Formatting your USB flash drive deletes all content stored on your drive.

To format the USB flash drive:

4. Insert a USB flash drive into the DVR while the DVR is on.
5. Click the **Menu** button. The Main Menu window opens.



Backup button

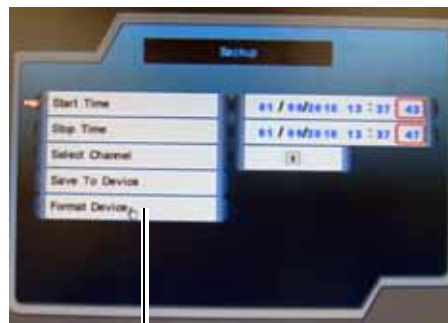

Click Format Device to begin formatting the USB flash drive.

Figure 25.0 Downloading the Safari plug-in.

6. Click the **Backup** button. The Backup window opens.
7. Click **Format Device** and then click **Yes** to begin formatting the USB flash drive.



Click Yes to format the USB flash drive.

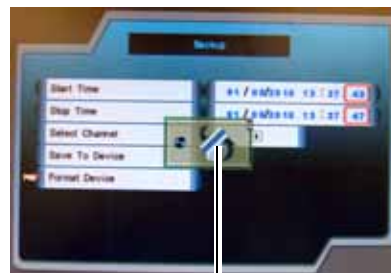

Indicates DVR is formatting USB flash drive.

Figure 25.1 : Format prompt screen.

8. Remove the USB flash drive from the DVR when formatting is complete.

Download the firmware from the Lorex website

1. Go to www.lorexctv.com and search for **LH3xx** (where xx is your model #). Download the latest firmware relevant to your model number.

NOTE: 4-channel firmware is different from the 8 & 16-channel firmware.

2. Extract the firmware to the USB flash drive. Do not extract the firmware into the Pictures or Movies folder.

NOTE: Firmware ends in a `.rom` extension.

Upgrade the DVR firmware

1. Power down the DVR by unplugging the power cord from the DVR.
2. Insert the USB flash drive into the DVR.
3. Turn on the DVR by plugging the power cord into the DVR.
4. Wait for the DVR to detect the USB flash drive. The firmware upgrade automatically begins.
5. Click **Yes** to begin the firmware upgrade. Wait for the firmware upgrade to finish.

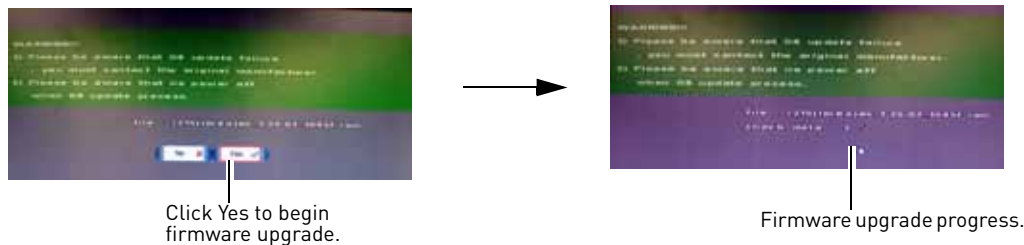

Figure 25.2 : Firmware upgrade window.

6. Power down the DVR by unplugging the power cord from the DVR and remove the USB flash drive.
7. Turn on the DVR by plugging the power cord into the DVR.

Enabling Easy Connect on your DVR

Once your unit is upgraded with the latest firmware, you can check if Easy Connect is enabled. By default, Easy Connect is set to **ON** after the firmware upgrade.

To check if Easy Connect is enabled:

1. Click **Menu**.

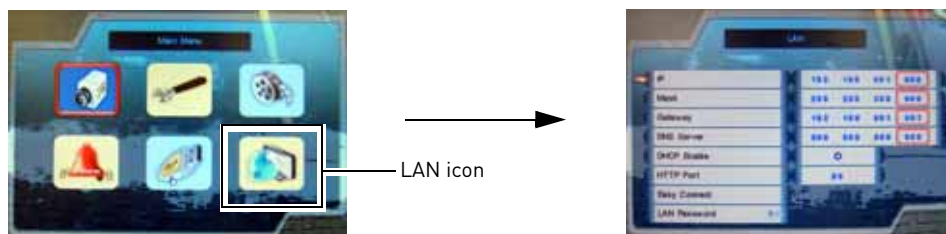

Figure 25.3 : Opening the LAN settings.

2. Click the **LAN** icon on the bottom right hand corner of the main menu.

3. Click **Easy Connect** in the LAN menu. The Easy Connect window opens (Figure 5).



A blue "O" indicates Yoics is enabled.
A red "X" indicates Yoics is disabled.

Only click to restart Yoics service in case of a connection problem with Yoics.

Allow 10 minutes for the changes to take effect.

Figure 25.4: Easy Connect menu.

4. Under Yoics Enable, a blue "O" indicates Yoics is enabled. Use the mouse scroll wheel to turn Yoics on or off.

NOTE: Click on **Reset Yoics** only if you have a connection problem with Yoics. Changes take effect in 10 minutes. After 10 minutes, re-login to your Yoics account.

Registering for an Easy Connect account

After you upgrade your DVR with the Yoics Easy Connect firmware, you must create a Yoics account and register your device with Yoics.

To register your DVR with Yoics:

1. Go to <http://lorex.yoics.com> and register for an account.

NOTE: There is no "www" in front of the address.



You must connect your DVR to a router connected to the internet before registering a Yoics account.

This ensures that upon account activation, Yoics will automatically detect your DVR.



Figure 25.5: Yoics registration screen.

2. After you log into Yoics, a message box indicates that a device has been detected by Yoics. Click **Complete Registration** to continue. A "Register New Devices" window opens.



Figure 25.6: Yoics device detection pop-up.

NOTE: If you do not see this pop-up window, double check that Easy Connect is enabled on your DVR.

NOTE: The DVR must be connected directly to a router through a hardwire connection.

- Under Yoics Device Name, enter in the desired name for your DVR. In this example, we named the system name to "DVR". Click **Register Now** to continue.

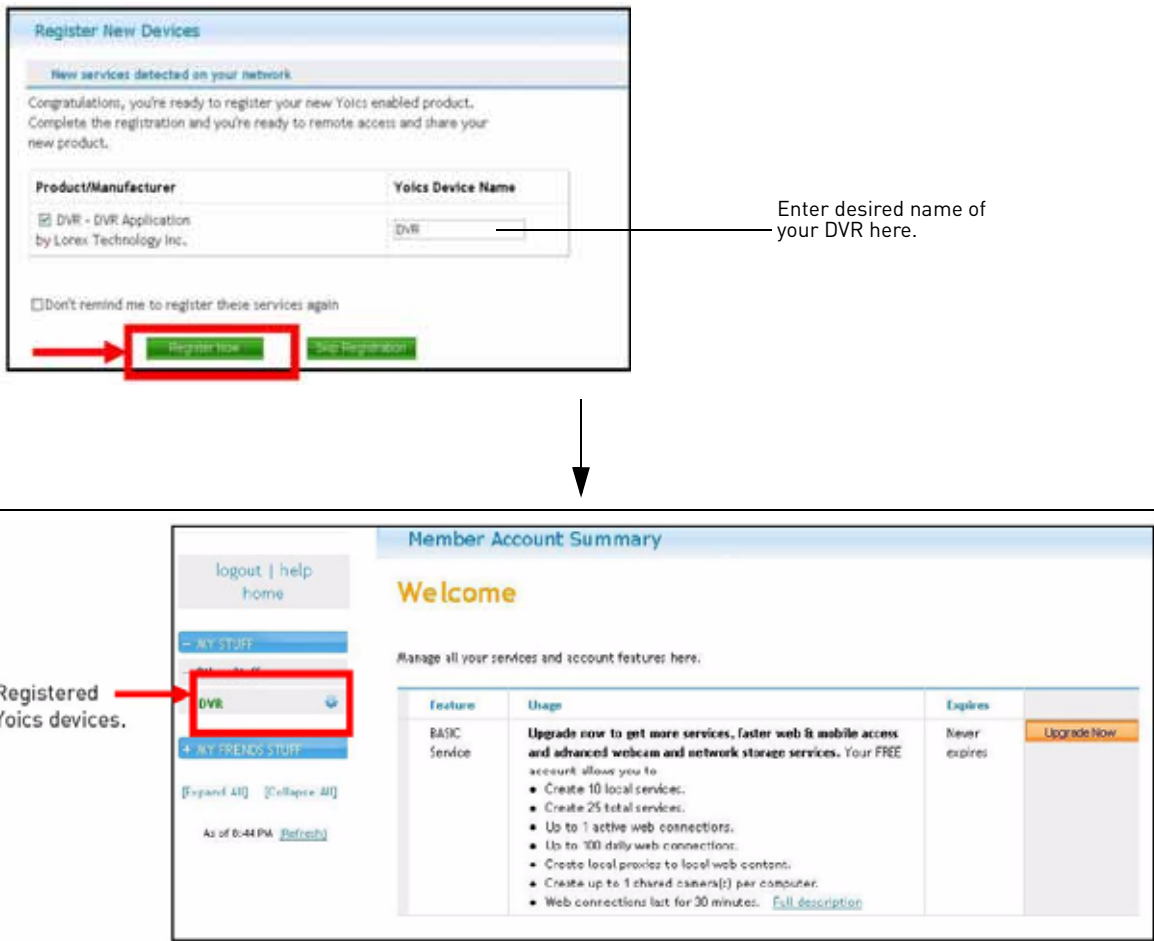

Figure 25.7: Register New Devices window. Your device appears on the left side bar under "My Stuff".

NOTE: You do not have to click the Upgrade Now button. This service is provided free of charge.

Connecting to your DVR using Easy Connect

Once you have logged into your Yoics account, you may connect to your DVR at any time.

To begin live viewing of your DVR:

- Log in to your Yoics account using **Internet Explorer**.
- Click the name of your system on the left side bar under "My Stuff" to connect to your DVR.

3. An ActiveX toolbar opens in the browser. Click the ActiveX tool bar and click **Install ActiveX Control** to continue.

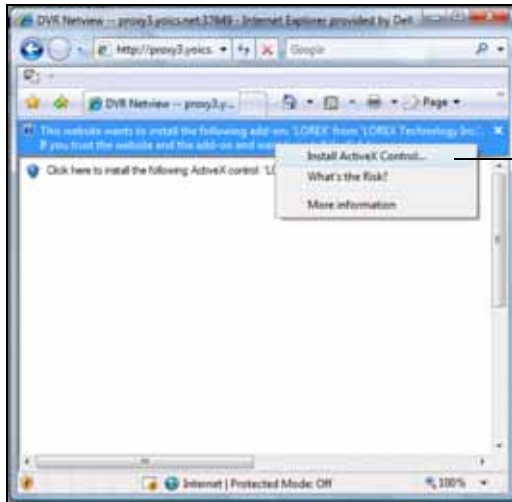

Click Install ActiveX Control.

NOTE: Your browser settings may prevent you from installing ActiveX.

Adjust your browser settings to allow for ActiveX installation.

Figure 25.8: ActiveX installation window.

4. Enter your DVR user name and password and click **LOGIN**. A second ActiveX installation pop-up window opens. Click **Install** to continue and connect to your DVR.



Click Install to install ActiveX.

Figure 25.9 : ActiveX initialization screen. Install ActiveX to connect to your DVR remotely.

NOTE: The connection times out after 15 minutes to conserve your bandwidth. Simply re-login to your account to begin remote viewing.

How port forwarding works

You need to enable port forwarding on your router to allow for external communications with your system for the following port:

- **80** (HTTP port)

NOTE: For added security, we strongly recommend changing HTTP port 80 on the system to *any desired port*—the port must not be blocked by your Internet service provider (ISP).

Computers, DVRs, and other devices inside your network can only communicate directly with each other within the internal network. Computers and systems outside your network cannot directly communicate with these devices. When a system on the internal network needs to send or receive information from a system outside the network (i.e. from the Internet), the information is sent to the router.

NETWORK EXAMPLE

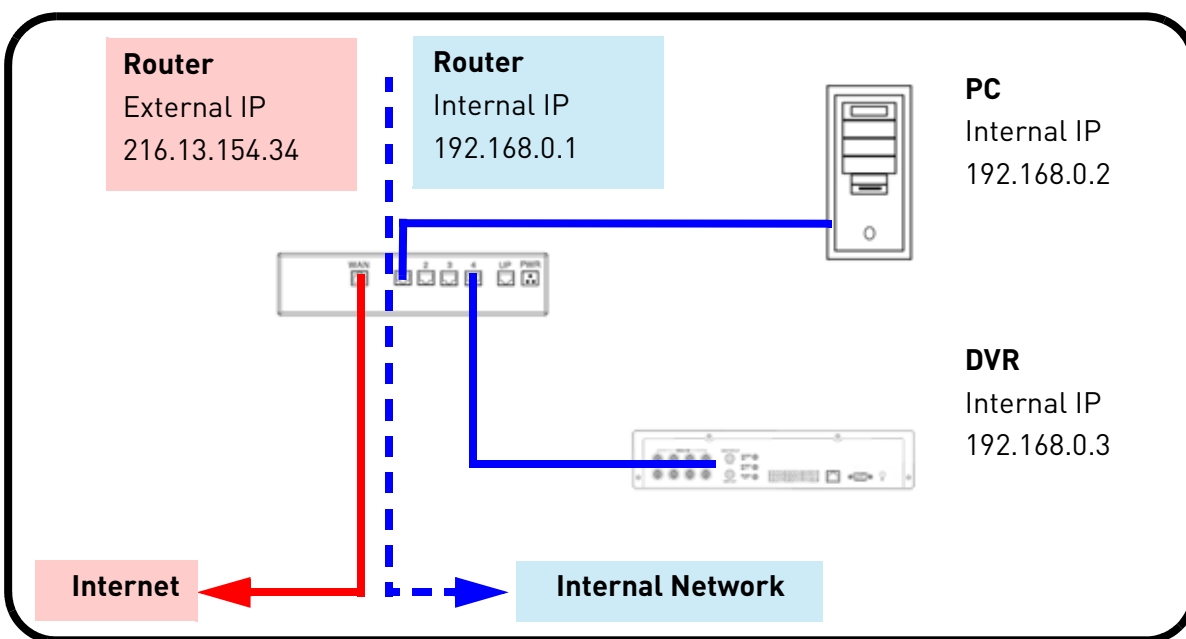

Figure 26.0 Internal and External network diagram.

When a computer on the Internet needs to send data to your internal network, it sends this data to the external IP address of the router. The router then needs to decide where this data is to be sent to. This is where setting up Port Forwarding becomes important.

Port Forwarding tells the router which device on the internal network to send the data to. When you set up port forwarding on your router, it takes the data from the **external IP address:port number** and sends that data to an **internal IP address:port number** (i.e Router External IP 216.13.154.34 to DVR Internal IP **192.168.0.3:80**).

The instructions found online in the Router Configuration Guides will assist you in the port forwarding configurations for a selection of different router models. Visit our **Consumer Guides Support** website at <http://www.lorextechnology.com> for more details.

LOREX AUTO PORT FORWARDING WIZARD

The Lorex Auto Port Forwarding Wizard is an exclusive software that easily automates router port forwarding. Before setting up a DDNS account, it is recommended to run the Auto Port Forwarding Wizard to port forward the required ports.

Installation

To install the Lorex Auto Port Forwarding Wizard:

1. Insert the system's software CD, and follow the instructions to launch the Lorex Auto Port Forwarding Wizard software.
 - The installation window opens.
2. Click **Next** to continue.

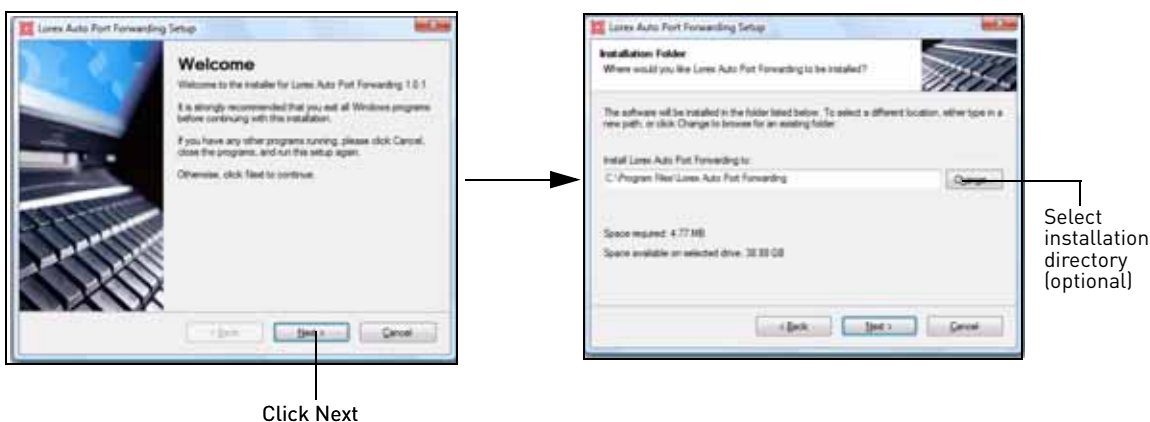

Figure 27.0 Auto Port Forwarding Wizard installation menu.

3. Click the **Change** button to change the default installation directory (optional). Click the **Next** button to continue.
4. Select the users who can see the Auto Port Forwarding shortcut (Optional). Click the **Next** button to continue.

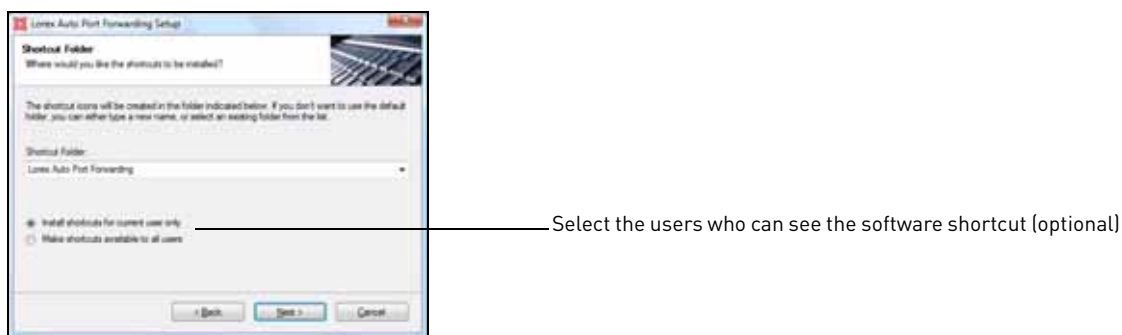

Figure 27.1 Auto Port Forwarding Wizard installation - user selection.

- Click the **Next** button and then click **Finish** to complete the software installation.



Figure 27.2 Completing the installation.



- Double-click the Lorex Auto Port Forwarding shortcut (Lorex Auto Port Forwarding) from your desktop to start the program.

Obtaining Your Router Model Number and Version

On most routers, the model and version number can be found underneath the router, printed on a sticker.

Example

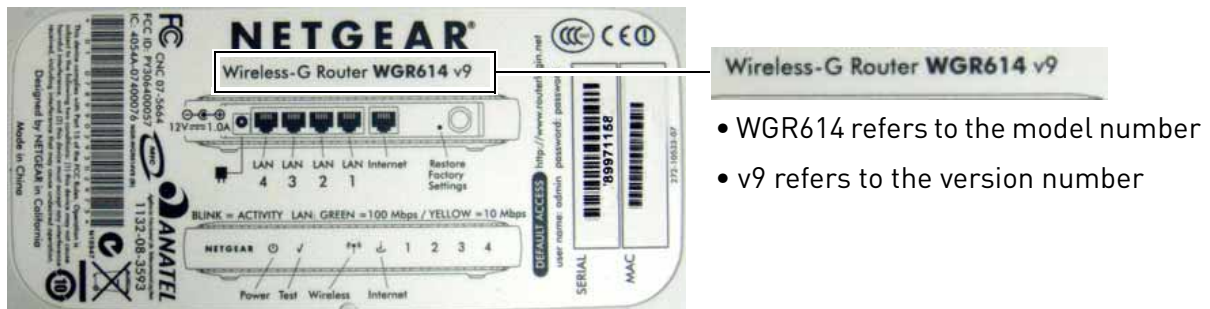

Figure 27.3 Finding your router model and version.

Configuration



You must have the following before you configure the software:

1. Your router's model number and version number
2. Your router's user name and password
3. Your Lorex device's IP address
4. Your Lorex device's port numbers that require port forwarding

Initial Startup: Select language

1. Click the Language drop-down menu and select a language (English, French, Spanish). Click the **Start** button to continue.



Software update section

Start button

Language drop-down menu



Download Now button

A software update includes an updated list of routers compatible with the Auto Port forwarding Wizard.

Figure 27.4 Initial setup window.

2. If software updates are available, click the **Download Now** button in the top-right corner.
 - Run the update file and install the latest version of the software.

Step 1: Populate the router database

The Auto Port Forwarding Wizard automatically populates a list of current routers, and detects the number of connected routers.

1. Click the **Next** button after the software detects your router configuration.



Click to update router database

Click to check for multiple routers

Figure 27.5 Router detection window.



If more than one router is detected, you may need to contact your ISP (Internet Service Provider) to port forward.

For details on configuring multiple routers, see "Configuring multiple routers" on page 73.

Step 2: Enter your router settings

- Under the Router drop-down list, select the model of your router.

OR

- Click the **Search** button () to enter the name of your router model.



NOTE: Click the **Auto Detect** button () if you have a Linksys or Netgear router (works with most Linksys or Netgear models).



Figure 27.6 Router settings window.

- Under Router IP, click the **Detect Router IP** button ().
 - The router's IP populates in the blank field. Click **OK** to exit the prompt.
- Under Username and Password, enter **the router's** username and password.
 - Optional: Under HTTP Type (default http://) and HTTP Port (default, 80), you may have to change the values depending on your router model. Consult your router manual for details.

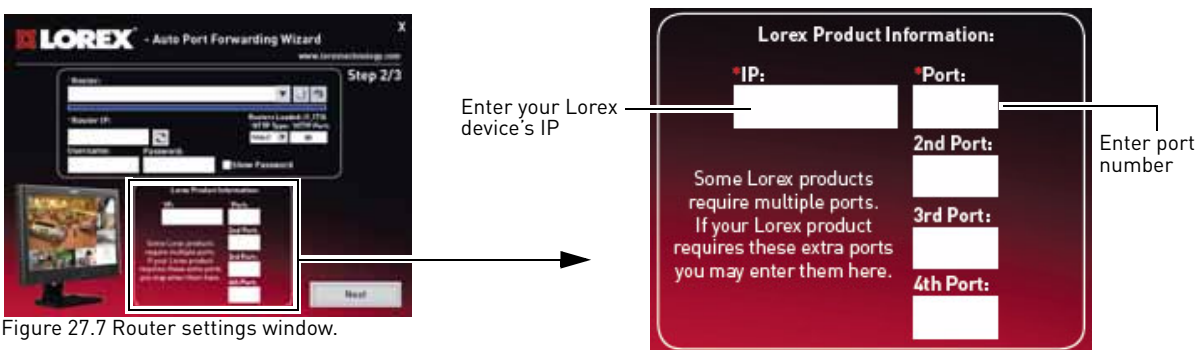

Figure 27.7 Router settings window.

- Under IP, enter the IP address of your Lorex device.
 - To find your system IP, exit to the main viewing mode, and then press the **INFO** button on your remote, or press the **RETURN** button on the front panel of the system.
- Under **Port**, enter the Web Port (**80**).
- Click **Next** to continue.

Step 3: Update the router settings

1. Click the **Update Router** button.
 - You will see your router window open. The Auto Port Forwarding Wizard automatically populates your router with the relevant information. This will take a few moments.

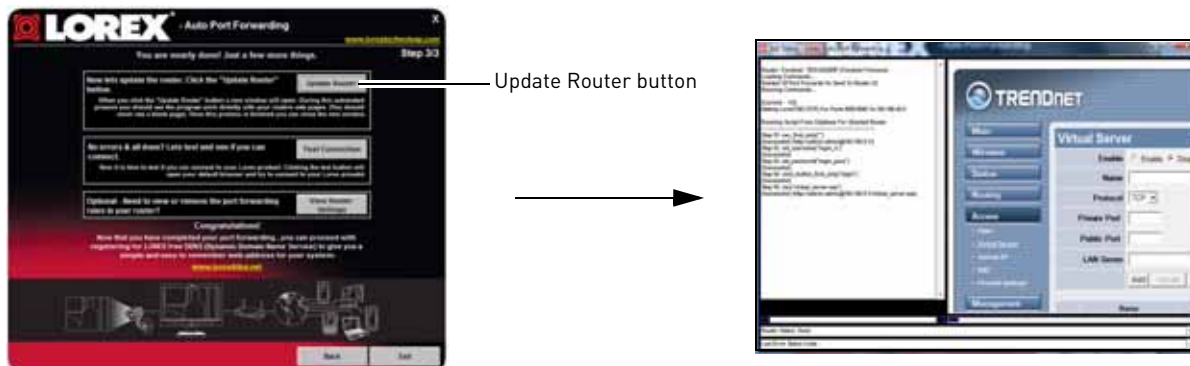

Figure 27.8 Router settings window.

2. Close the update window when the update finishes.

Step 4: Test your connection

1. Click the **Test Your Connection** button.
 - Your system's default browser opens and connects to your **Lorex device**.

NOTE: Ensure that Internet Explorer is your system's default internet browser.

NOTE: A window opens that prompts you to enter in your **DVR's** user name and password (do not enter your DDNS log in information).

NOTE: ActiveX warnings may appear. Accept all ActiveX installation warnings to connect to your system.

Configuring multiple routers

Your network may have two or more connected routers. During the initial launch of the auto port forwarding wizard, the program scans the network to detect the number of connected routers.

To check for multiple routers:

1. Click the **Detect Multiple Routers** button ().
 - A list of connected router populates in the window.



Figure 27.9 Router settings window.

- The "Possible 1st Router" refers to the router directly connected to your system. This is the router that requires the port forward information.
- The "Possible 2nd Router" refers to the router immediate to the internet connection. This is the router that requires you to configure a DMZ host connection.

Scenario A: Router/Modem combination + Router

- You may have a router/modem combination, with a second router in your network.

Scenario B: Multiple Routers

- You may have two routers in your network.

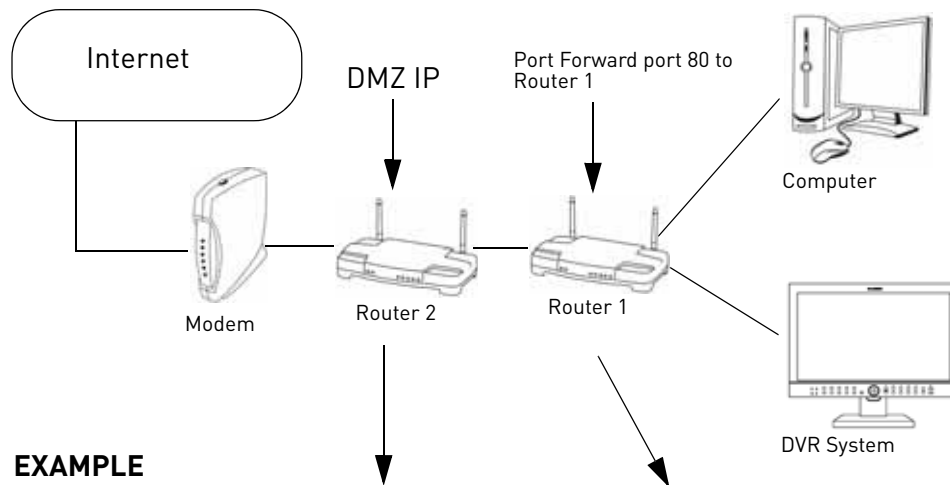

EXAMPLE

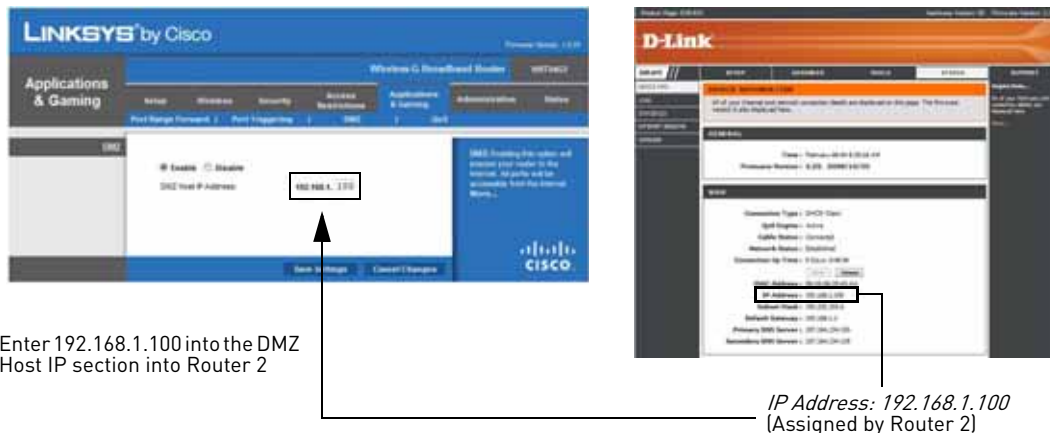

Figure 27.10 Configuring multiple routers.

In both scenarios, the router that is immediate to the internet connection (Router 2 in illustration) must act as a "bridge" to another router (Router 1 in illustration). The Auto Port Forwarding Wizard must connect to Router 1.

A proper DMZ configuration in Router 2 allows all incoming traffic going through Router 2 to automatically pass to Router 1. Router 2 acts as a "dummy" router and passes all the incoming data onto Router 1. Router 1 is the router that needs the port forwarding information.

Configuring a DMZ host connection

- Connect to "Router 1" on your network (referred to as "Possible 1st Router" in the Auto Port Forwarding Wizard). Obtain the IP address of Router 1. Usually this can be found in the "Status" section of your router menu. The IP should begin with "192.168...." This IP address is your DMZ IP.
- Enter the IP address obtained from Router 1 into the DMZ section of Router 2.
- Once you have configured Router 2 with a DMZ connection, run the Auto Port Forwarding Wizard to begin auto port forwarding to Router 1.
- Consult your router's owner's manual for details on configuring DMZ settings.

Example

DMZ stands for Demilitarized Zone. Enabling a DMZ IP on your router enables one of the routers to pass information onto the second router.

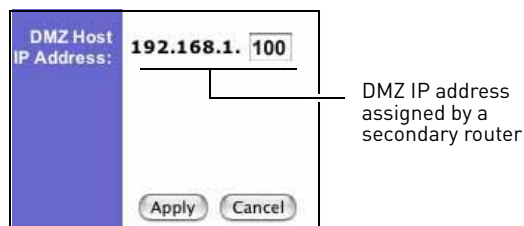
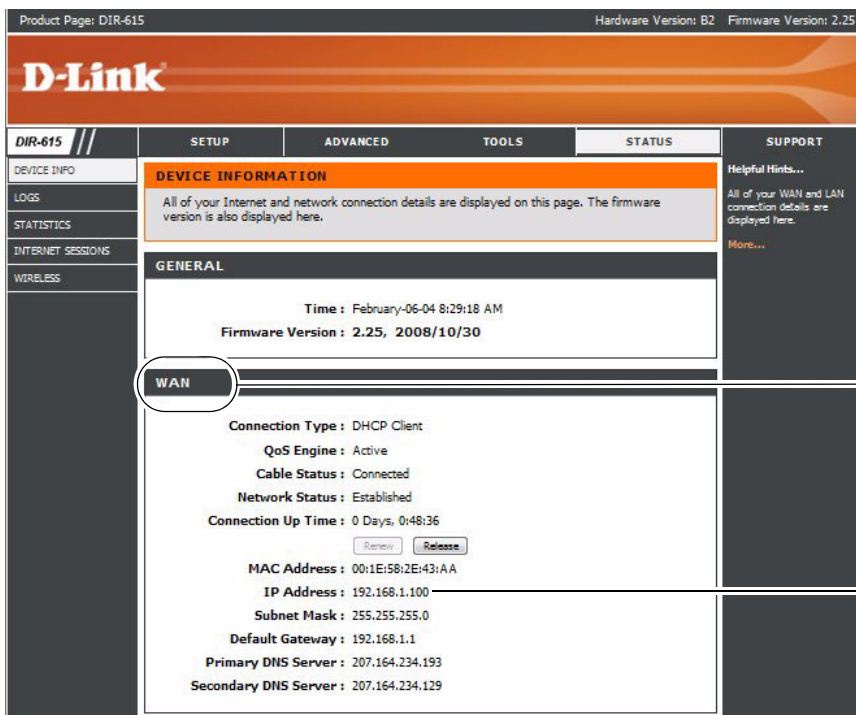

Figure 27.11 Entering DMZ information.

Locating your Router IP - The Status Page

The "Status Page" of a router normally includes the router's vital information such as the IP address.

EXAMPLE



The IP information is normally under a header called "WAN" or "Internet Port". Each router has different terminology.

Router IP assigned by the main router. Enter this IP into the DMZ section of the primary router.

Figure 27.12 Router status page.

Setting Up DDNS

Lorex offers a free DDNS service for use with your system. A DDNS account allows you to set up a web site address that points back to your Local Network. The following outlines how to set up your free Lorex DDNS account.

To setup your free Lorex DDNS account:

1. In your browser, go to <http://lorexddns.net> and click **Create Account**.
2. Complete the **Account Information** fields with your personal information. Complete the **Warranty Information** with your purchase details (optional).
3. Complete the System Information fields:
 - **Product License**: Select your product model from the Product License drop down menu (e.g. LH314)
 - **<Product Code> - <MAC Address>**: The physical address of your product on your network. Do not include hyphens/dashes.
 - **URL Request**: Choose a URL for your DDNS connection (i.e. your name, your company or business name, or anything of your choice.)
4. Once the information has been entered, click **Create New Account**.
5. Your Account information will be sent to you at the email Address you used in Step 2.



Figure 28.0 Create a DDNS account



Figure 28.1 Enter personal information



Figure 28.2 System information

You will need this information for remote access to your system. Record your information below

Username: -----

Domain name*: -----

Password: -----

* Only the first part of the Domain Name is required for setup on the system. For example, if the full domain sent is *tomsmith.lorexddns.net*, you only need to enter **tomsmith** on the system.

Enabling DDNS on your system

Once you have registered for free DDNS service, use the information in the confirmation email to configure DDNS settings on your system.



Figure 29.0 DDNS setup in DVR Netviewer

ATTENTION: You *MUST* enter your DDNS information *LOCALLY* before attempting remote access.

Prerequisites

1. Connect the system to your router.
2. Obtain your system's IP number and Port number.
 - From the Main Menu, click , and then click **Information**. Your IP address MAC address, and Port number are under LAN.

To enable DDNS on your system:

1. Open Internet Explorer (version 6 or above) and enter **http://**, followed by the **IP address** of your DVR in the address bar, followed by a **semi-colon**, and then the **port number** (i.e. http://192.168.2.5: 80)
 - The DVR Netviewer opens.
2. Login using your **LAN user ID** and **password** (see "Network User Profiles" on page 47 for a table of system passwords).
3. Click the **Setup button** on the top-right corner of the window. The Setup menu opens.
4. Click the **DDNS** tab.
5. Under DDNS Select, click the drop-down menu and select **http://lorexddns.net**
6. In the corresponding text fields, enter your **DDNS username** and **password**.

NOTE: Obtain this information from the confirmation email after registering for the free Lorex DDNS service.
7. Under DDNS Domain Name, enter only the **first portion of your DDNS domain** from the confirmation email. For example, if your domain name is tomsmith.lorexddns.net, you only need to enter *tomsmith* in the text field.
8. Click **Apply** to save your settings.

NOTE: Once you have saved your DDNS settings, you must reset your system in order for the changes to take effect. Disconnect and reconnect the power cable from the rear panel to reset. Please allow 10~15 minutes for the DDNS servers to update with your new DDNS address.

Networking Checklist

Use this checklist to confirm you have completed all the steps of the Network Setup.

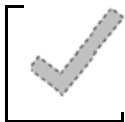

I have the following:

- High-Speed Internet
- Router
- Ethernet cable (included with the system)
- Computer with Internet Explorer 6 or later

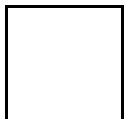

I have turned off the system and performed the following:

- Connected the Ethernet cable to the back of the system
- Connected the other end of the Ethernet cable to my router
- Entered the IP address and Default Gateway from ipconfig in my system's LAN settings

NOTE: Network Setup will not work if you do not have a router.

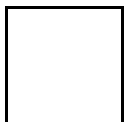

I have found my System Information:

- Press the  button **twice** on the remote control.

OR

- From the Main Menu, click , and then click **Information**. Your IP address and MAC address are under LAN.

My IP Address is: _____

My MAC Address is: _____

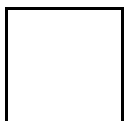

I have enabled Port Forwarding on my router:

- **Port 80**

NOTE: For added security, we strongly recommend changing HTTP port 80 on the system to *any desired port*—the port must not be blocked by your Internet service provider (ISP). For details on changing your ports, see "Changing Ports On Your System" on page 42.

NOTE: Each router is different, so port forwarding settings vary by model. Please visit us on the web at www.lorexttechnology.com for assistance with the latest types of routers. If your router is not listed, please refer to your router's manual or contact your router's manufacturer for assistance.

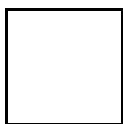

I have configured DDNS for remote access to my system:

Go to www.lorexddns.net and create a new account

Domain: _____

User ID: _____

Password: _____

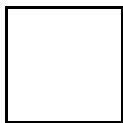

I have configured my system to connect to the DDNS server:

ATTENTION: You *MUST* enter your DDNS information *LOCALLY* before attempting remote access.

To enable DDNS on your system:

1. Open Internet Explorer (version 6 or above) and enter the **IP address** of your DVR in the address bar (i.e. 192.168.xxx.89). DVR Netviewer opens.
2. Log in using your **LAN user ID** and **password** (by default, **ID 9; password 3333**).
3. Click the **Setup button**. The Setup menu opens.
4. Under Network, click **DDNS**.
5. Under DDNS Select, click the drop-down menu and select **http://lorexddns.net**
6. In the corresponding text fields, enter your **DDNS username** and **password**.

NOTE: Obtain this information from the confirmation email after registering for the free Lorex DDNS service.

7. Under DDNS Domain Name, enter only the **first portion of your DDNS domain** from the confirmation email. For example, if your domain name is *tomsmith.lorexddns.net*, you only need to enter *tomsmith* in the text field.

8. Click **Submit** to save your settings or click **Cancel** to exit without saving.

NOTE: Once you have saved your DDNS settings, you must reset your DVR in order for the changes to take effect. Disconnect and reconnect the power cable from the rear panel to reset.

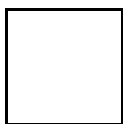

I can access my system from a remote PC:

To access your system remotely:

1. Open Internet Explorer and enter your **DDNS address** from the confirmation email. For example, *tomsmith.lorexddns.net*
2. Log in using your **LAN user ID** and **password**. See table below.

Remote/LAN Viewing 4/ 8/ 16 Channel		
LEVEL	ID	PASSWORD
GUEST	7	1111
USER	8	2222
ADMIN	9	3333

MOBILE CONNECTIVITY

You can remotely view camera streams from your DVR on your iPhone™, Windows Mobile 6™ or Blackberry™.

Compatible Mobile Viewing Devices

- iPhone (3.1.2 and above)
- Windows Mobile 6.0 devices or later (touch screen only)
- Blackberry 3G 9000 and up

NOTE: Instant Mobile Viewing on an iPhone™ using an iPhone™ App. Free download available from Apple™ Store under the name “Lorex Live”. Compatible with iPhone™ version 3.1.2 and above. Selectable one channel live viewing. Mobile phone data plan is required (not included). Router port forwarding is required.

NOTE: Instant Mobile Viewing on Windows Mobile™ 6.0 and above (free download available from Lorex web site. Selectable one channel live viewing. Mobile phone data plan is required (not included). Router port forwarding is required.

Before You Begin

You will need the following before you can start mobile viewing on your iPhone or Windows Mobile device:

- **Your DVR’s DDNS address**
For details, “see “Setting Up DDNS” on page 76.
- **The Port Number of your DVR**
For details, see “Lorex Auto Port Forwarding Wizard” on page 69 of your owner’s manual for details on port forwarding, and retrieving your system’s port number.
By default, the port number is **80**.

User name and Password of your DVR:

Remote/LAN Viewing

4/ 8/ 16 Channel		
LEVEL	ID	PASSWORD
GUEST	7	1111
USER	8	2222
ADMIN	9	3333

Mobile Connectivity on the iPhone / iPad

iPhone Users

To connect to your DVR using the iPhone, you need to download and install the **Lorex Live** application from the App Store.

iPad Users

To connect to your DVR using the iPad, you need to download and install the **Lorex Live Plus** application from the App Store.

! You must port forward your router before you can connect to your system using a mobile device (i.e. iPhone/iPad)

NOTE: You will need to create an iTunes account to download Apps from the Apple App store. A valid credit card is required to create an iTunes account.

Downloading the Lorex Live Application

To download the Lorex Live / Lorex Live Plus application using your iPhone/ iPad:

1. Touch the  (App Store) icon to open the App Store.
2. Touch the **Search** icon on the bottom of the screen. Search for **Lorex Live / Lorex Live Plus** and then touch the **Search** button.
3. Touch the **FREE** button, then touch **Install** to download and install the program.
 - The App will install on your iPhone / iPad and you will see the following Lorex Live / Lorex Live

Plus icon on your application list: 

Connecting To Your DVR - iPhone Users

To connect to your DVR on your iPhone:

1. Touch  to start the application. The Setup screen appears.



Figure 30.0 Lorex Live setup screen (iPhone version).

2. Enter your DVR's DDNS address in full (i.e. tomsmith.lorexddns.net), Port Number, ID and Password.
3. Touch the blue **Connect** button on the top right corner of the screen. The iPhone connects to your DVR and displays a streaming video in a single channel view.

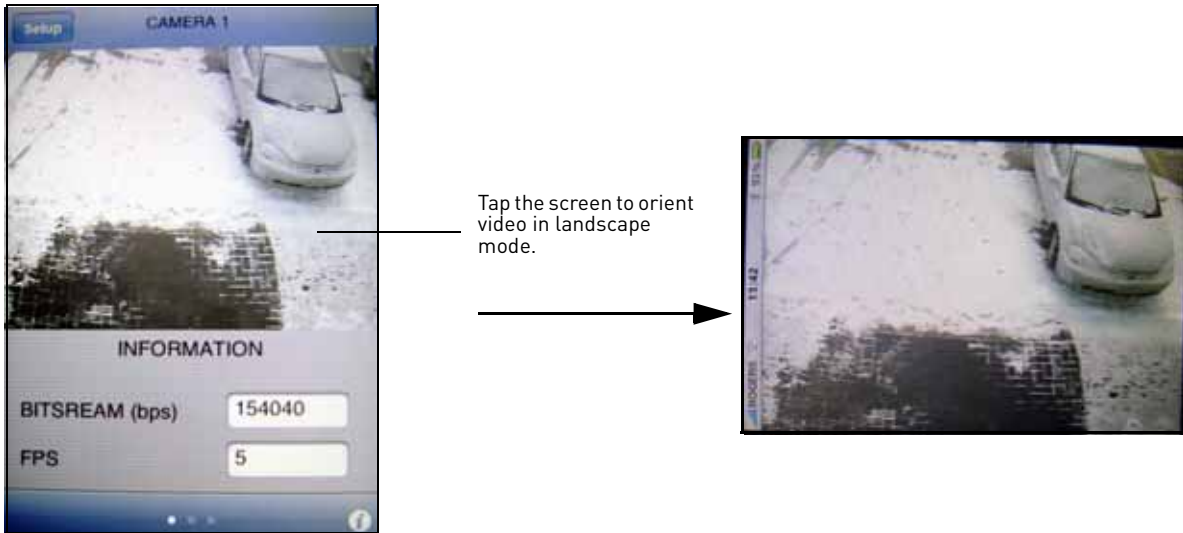

Figure 30.1 Main viewing window.

The Lorex Live Interface

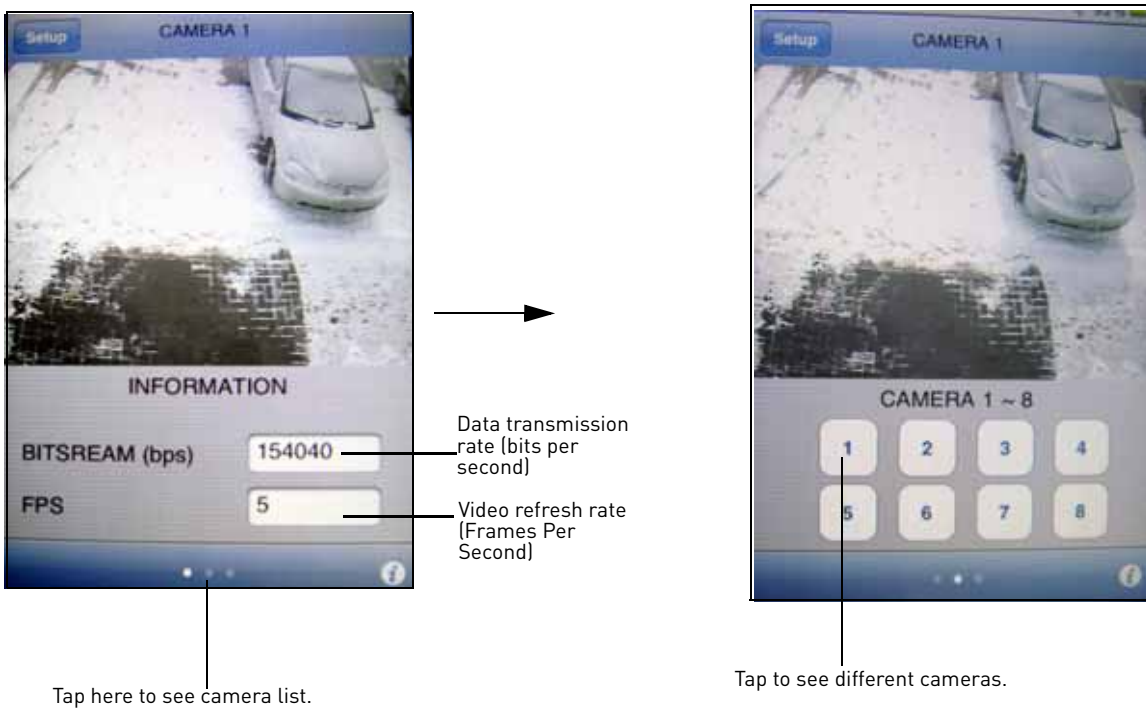

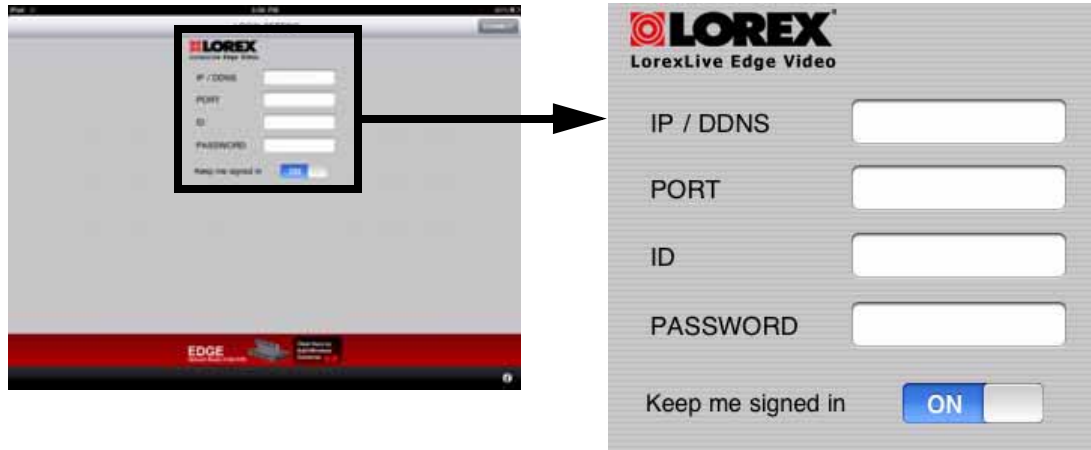

Figure 30.2 : Viewing channel lists.

Connecting To Your DVR - iPad users

To connect to your DVR on your iPad:

1. Touch  to start the application. The Setup screen appears.



2. Enter your DVR DDNS address in full (i.e tomsmith.lorexddns.net), DVR Port Number, DVR ID and DVR Password.
3. Touch the **Connect** button on the top right corner of the screen. The iPad connects to your DVR and displays streaming video.

Tip: In single channel view, tap the video twice to enlarge it to full screen.



[4-channel model interface shown]

NOTE: The navigation is identical to browsing the system through Internet Explorer or Safari.

Mobile Connectivity on Windows Mobile

To connect to your DVR using Windows Mobile smartphones, you need to download and install the Mobile View application.

To download Mobile View:

1. Go to www.lorextechnology.com and search for LH3xx (where xx is the model #). Download the Mobile View application.
2. Install the Mobile View application. See your smartphone's owner's manual for program installation procedures.

NOTE: The Mobile View application is a **.CAB** file. Do not unzip the file.

Connecting to your DVR using Mobile View

To start Mobile View:

1. Touch the  (Mobile View) icon in the Start menu.

Touch the Mobile View icon to start remote viewing.



! You must port forward your router before you can connect to your system using a mobile device (i.e. Windows Mobile)

Figure 30.3 Launching Mobile View

2. Enter your DVR's IP address or DDNS address, Port Number, User name and Password.
3. Touch the **Connect** button to begin live viewing.



Touch Connect to start Live viewing.



Tap the screen to orient video in landscape mode.

Touch the Camera tab to view channel list.



Figure 30.4 Windows Mobile 6.0 remote connectivity interface.

Mobile Connectivity on the Blackberry

Requirements:

- Blackberry 3G 9000 or higher
- Blackberry Desktop Manager Software

Prerequisites:

- Download the Mobile View software at www.lorexttechnology.com. Extract the file into a folder.
- Obtain your Blackberry's **APN** (Access Point Name) from your service provider, and enable APN on your Blackberry.

! You must port forward your router before you can connect to your system using a mobile device (i.e Blackberry 3G 9000)

Installing Mobile View on the Blackberry:

1. Connect the Blackberry to your computer using a USB cable.
2. Open Blackberry Desktop Manager.
3. Click **Application Loader**.
4. Under Add/Remove Applications, click the **Start** button.



Start button

Figure 30.5 Blackberry Desktop Manager.

5. Click the **Browse** button.
6. Locate the Mobile Viewer file. Select the file and then click **Open** to install the file.

NOTE: The file name ends in a **.alx** extension).



Figure 30.6 Installing Mobile View on the Blackberry.

7. Click **Next** and then click **Finish** to complete the installation.
 - Wait for the installation to complete.

Enabling APN (Access Point Name)

In order for Mobile View to run, you must enable APN (Access Point Name) on your Blackberry. Contact your service provider for your Blackberry's APN name.

To enable APN:

1. Press the Menu button ().
2. Open the **Options** menu.



Figure 30.7 Opening the Options folder.

3. Select **Advanced Options** → **TCP/IP**

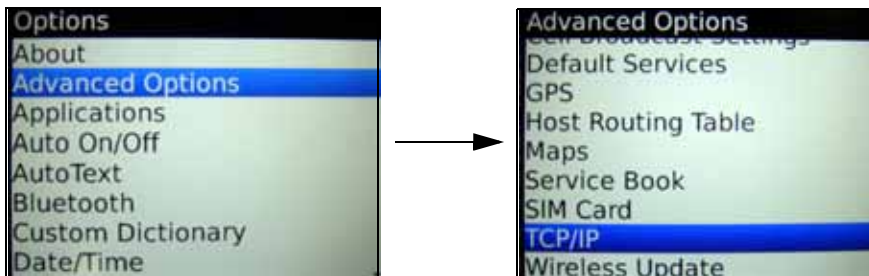

Figure 30.8 Opening APN settings menu.

4. Select the checkbox beside **APN Settings** to enable APN.

Example

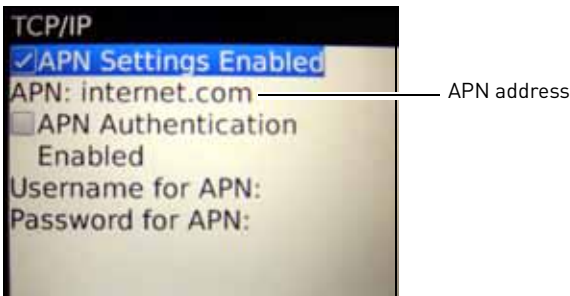

Figure 30.9 Enabling APN settings.

5. Beside APN, enter your APN. **You must obtain the APN from your local service provider.**
6. Exit to save your settings.

Connecting to your DVR

You can view your DVR remotely using your provider's 3G Network. Data charges may apply. See your cellphone carrier's network data plan for details.

1. Press the Menu button ().
2. Open the **Downloads** folder.



Figure 30.10 Opening the Downloads folder.

3. Open the **MobileView** program.

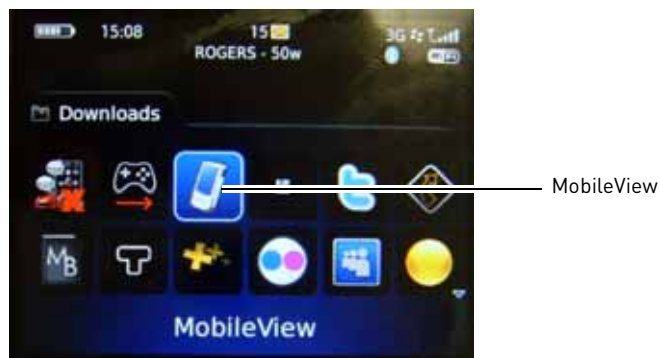

Figure 30.11 Opening Mobile View.

4. Enter your DDNS address, DVR Port number and your DVR username (ID) and password.

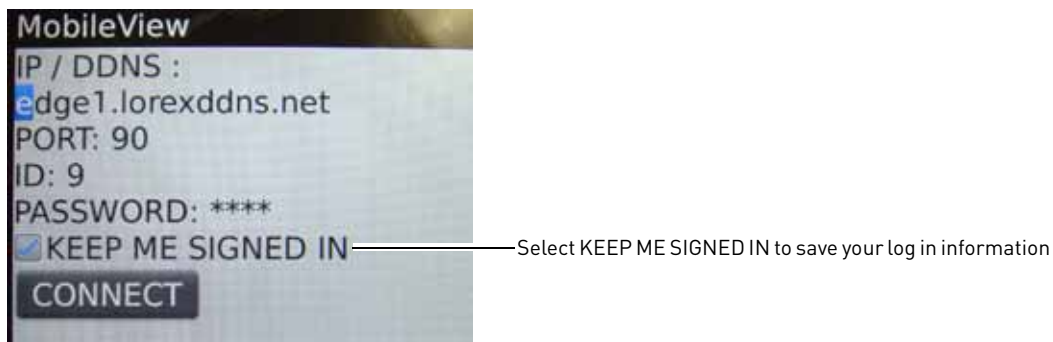

Figure 30.12 Connecting to your DVR.

5. Click the **CONNECT** button to begin live viewing.

Viewing Your DVR

Once you have entered your DVR's system information, you can begin live viewing. You can view a single channel of video stream of your DVR. Split screen view is not available.

NOTE: If you exit Mobile View, you must wait 30 seconds before starting Mobile View again.

To change the channel view:

- Press the number keys to jump to the desired channel (i.e. press 3 to switch to channel 3).

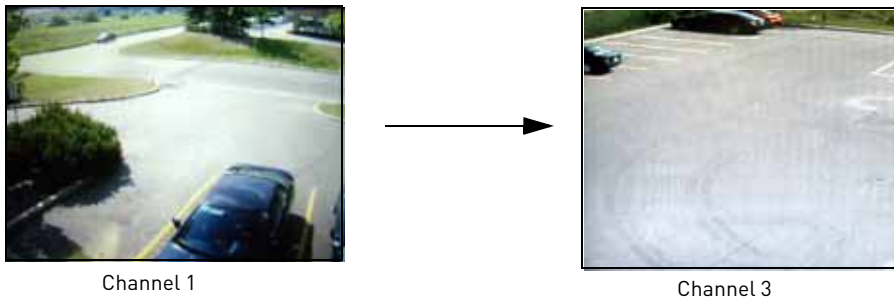

Figure 30.13 Connecting to your DVR.

Viewing Tips

- If you have wireless internet access at home, you may switch your Blackberry into WiFi mode. This allows you to monitor your system without incurring data charges on your 3G data plan.
- If your connection disconnects, wait 30 seconds before restarting Mobile View.

APPENDIX A: SYSTEM SPECIFICATIONS

Specifications are shared among 4/8/16-channel models unless specifically note d.

EDGE SERIES DVR

Description	Specification		
	4CH	8CH	16CH
Hard disk capacity	Maximum 1 HDD up to 1TB, 100% duty cycle		
Operating system	Linux (embedded)		
Backup	USB flash drive (front panel port <i>only</i>)		
Backup file format	MOV		
Compression	H.264		
Recording resolution	NTSC: 640x240, 640x480, 320 x 240; PAL: 640x256, 640x512, 320 x 256		
Recording speed	120 fps @ 640x240 (NTSC) 100 fps @ 640x256 (PAL)	240fps @ 320 x 240 (NTSC) / 200 fps @ 320 x 256 (PAL)	
Recording schedule	Daily, Weekly—adjust specific hour per channel		
Pre/Post alarm recording	3~10 sec. (pre); 1~255 sec. (post)—programmable per camera		
Event/Log search	Up to 4096 for alarm, motion, video loss, power loss 4ch / Up to 8192 event logs for 8&16 ch.		
Playback	Single, Quad	Single, Quad, 8-channel simultaneous	Single, Quad, 8, 16-channel simultaneous
Video inputs	4 x 1Vp-p, 0.75 ohms, BNC	8 x 1Vp-p, 0.75 ohms, BNC	16 x 1Vp-p, 0.75 ohms, BNC
Video outputs	1 x VGA	1 x DVI	
Audio inputs	2 x line-in, RCA		
Audio outputs	2 x line-out, RCA		
Supply voltage	120 VAC-240 VAC, 12V DC, 2.5 A, 50/60 Hz	120 VAC-240 VAC, 12V DC, 3 A, 50/60 Hz	
Power consumption	Approximately. 30 watts		
Operating Temp Range	41 ^o ~104 ^o F / 5 ^o ~40 ^o C		

Appendix A: System Specifications (cont'd.)

EDGE SERIES DVR

Description	Specification		
	4CH	8CH	16CH
Alarm inputs	4 x TTL	4 x TTL, programmable as NC/NO	
Alarm outputs	1 x relay with NO/NC contact		
Activity detection	4 x 3 grid, sensitivity levels: 100	8 x 6 grid, sensitivity levels: 100	
Remote functions	Live view, live recording, search, setup, backup		
Network speed control	10 levels (28.8Kb~8MB) / sec.		
Network protocol	TCP/IP, DDNS, Web		
Network interface	10 / 100Mbps Base-TX, RJ-45		

Product Information

EDGE SERIES 4/8/16-channel

Description	Specification
-------------	---------------

Unit Weight 3.19 lbs / 1.45 kg

Unit Dimensions (WxHxD) 11.4" x 1.6" x 7.0"
290 mm x 42 mm x 180 mm

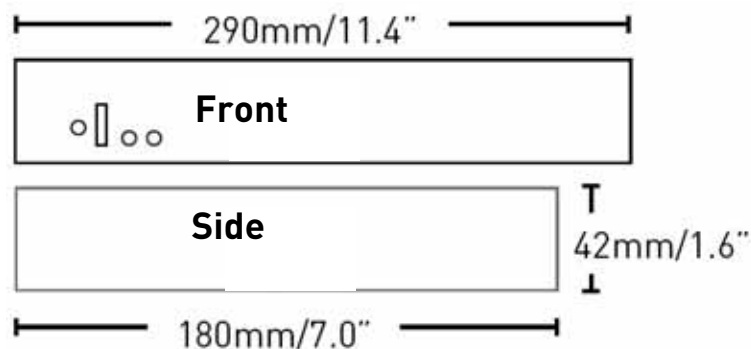

Edge⁺ and Edge Mini Specifications

SYSTEM	
Operating System	Linux (embedded)
Pentaplex	Simultaneous View, Record, Playback, Backup & Remote Monitoring
Number of Channels	4 Channel (Edge mini) 4/8/16 Channel (Edge & Edge+)
INPUTS/OUTPUTS	
Video IN	4/8/16 x 1Vp-p, 75ohms, BNC
DVI Out*	DVI compatible. DVI to VGA Converter included.
VGA Out	Only available in Edge 4ch & Edge mini
Audio IN	2 Line in(RCA)
Audio Out	2 line out(RCA)
USB Port	2 front & back
Alarm IN**	4 x TTL, programmable as NC/NO
Alarm Out**	1 x Relay with NO/NC contact
PTZ control***	By Terminal connector (RS485)
DISPLAY	
Live Display	1 or 4 (4ch) 1 or 4 or 9 (8ch) 1 or 4 or 9 or 16 (16ch)
Live Display Speed	120 (4ch)/ 240 (8ch)/ 240 (16ch) NTSC 100 (4ch)/ 200 (8ch)/ 200 (16ch) PAL
OSD	ON/OFF
Activity Detection	6 x 8 grid
Sensitivity levels	100
System Control	USB Mouse, Handheld Remote Control & Flex IR** Front Panel Controls***
Firmware Upgrade	Via USB device
User Authority	ADMIN/USER/GUEST
RECORDING	
Video Compression	H.264
Audio Compression	ADPCM

*Not included in Edge 4ch and Edge mini
 **Not included in Edge mini
 ***Only included in Edge+

Recording Speed & Resolution - 4 Channel	120 fps (NTSC), 100 fps (PAL) @ 640 x 240 NTSC / 640 x 256 PAL 60 fps (NTSC), 50 fps (PAL) @ 640 x 480 NTSC / 640 x 512 PAL
Recording Speed & Resolution - 8/16 Channel	240 fps (NTSC), 200 fps (PAL) @ 320 x 240 NTSC / 320 x 256 PAL 240 fps (NTSC), 200 fps (PAL) @ 640 x 240 NTSC / 640 x 256 PAL 120 fps (NTSC), 100 fps (PAL) @ 640 x 480 NTSC / 640 x 512 PAL
Recording Resolution Setting	Programmable per camera
Recording Quality Control	5 levels
Image Size	8.51 Kbyte (640x480,640x512), 11.2 Kbyte (640x240, 640x256) 14.13 Kbyte (320x240, 320x256)
Recording modes	Continuous, motion, alarm
Pre Recording	Max. 10 seconds
Post Recording	Max. 255 seconds
Alarm Recording	Programmable per camera
Alarm Recording	Programmable per camera
Reliability	Watch-Dog, Auto-recovery after power failure
PLAYBACK	
Playback Display	1,4 (4ch), 1,4,9 (8ch), 1,4,9,16 (16ch)
Playback Speed	Variable up to 60x
Playback Players	Apple QuickTime Player
Search	By time & event
STORAGE & ARCHIVE	
Storage	Up to 1 HDD (SATA)
Maximum Capacity	Up to 2TB
Backup Media	USB Flash Drive (max 4GB)
Backup File Format	MOV file (Codec included)
Bookmark Archiving	Supported
Email notification	Text (4ch), Snap Shot attachment (8/16ch)
Mobile connectivity	Blackberry™ - 9000 Series and above, iPhone™ - 3.1.2 and above, Windows Mobile™ smart phones - 6.0 and above touch screen smart phones
DDNS	Free Lorex DDNS
Web Server Port	Programmable by User
Network Protocol	LAN, DHCP, Dynamic IP, DDNS
Network Interface	10/100-Base-TX, RJ-45

CONNECTIVITY

Easy Connect	1. Yoics Enabled (registration required) 2. Lorex Auto Port Forward Wizard
Software	Web browser
Supported Operating Systems	Windows™ XP, Vista, 7 and Apple Mac OSX 10.5 or later, (via Safari browser)
Browsers	Internet Explorer, Safari
Network Speed Control	10 levels (28.8Kb ~ 1.5MB)/sec.

GENERAL

Power Consumption	Approx. 30 watts
Supply Voltage	120VAC-240VAC, 12VDC , 2.5A(4ch) 3A(8/16ch), 50/60Hz
Unit Dimensions (W x D x H)	Edge mini (W x D x H) 7.29" / 182.4mm X 7.74"/193.8mm X 1.82"/45.5mm Edge, Edge+ (W x D x H) 11.6" /290mm x 7.2"/180mm x 1.67"/41.8mm
Unit Weight (KGs)	Edge mini 0.9±0.1 kg/1.98±0.22 lbs Edge, Edge+ 1.15±0.1 kg/2.54±0.22 lbs (4ch) ; 1.45±0.1 kg/3.2±0.22 lbs (8/16ch)
Operating temperature	41° ~ 104° F / 5° ~ 40° C
Humidity	10 ~ 75% NC

As our products are subject to continuous improvement, Lorex Technology Inc. and its subsidiaries reserve the right to modify product design, specifications, and prices without notice and without incurring any obligation. *E&OE*

APPENDIX B: CONNECTING MOTION / ALARM DEVICES

You can enable Motion Detection and Alarm control from the Main Menu. You can also connect additional motion sensor devices to the system (i.e. motion sensors, door/window sensors) with a D-sub 9 connector (not included). Use a motion detector or sensor to send a signal to the system to begin camera viewing and recording on the matching camera channel (when enabled in the Menu).

NOTE: Some soldering is required when using a D-sub 9 connector.

Installing a Sensor on the EDGE Series

To connect an external alarm sensor to the system:

1. Connect a **D-SUB 9 connector** (not included) to the **ALARM I/O** port on the rear panel.
2. Connect Alarm-In wires to pins 1-4; connect NC wire to pin 6 connect NO open to pin 7.
3. Connect the ground wire to pin 9.

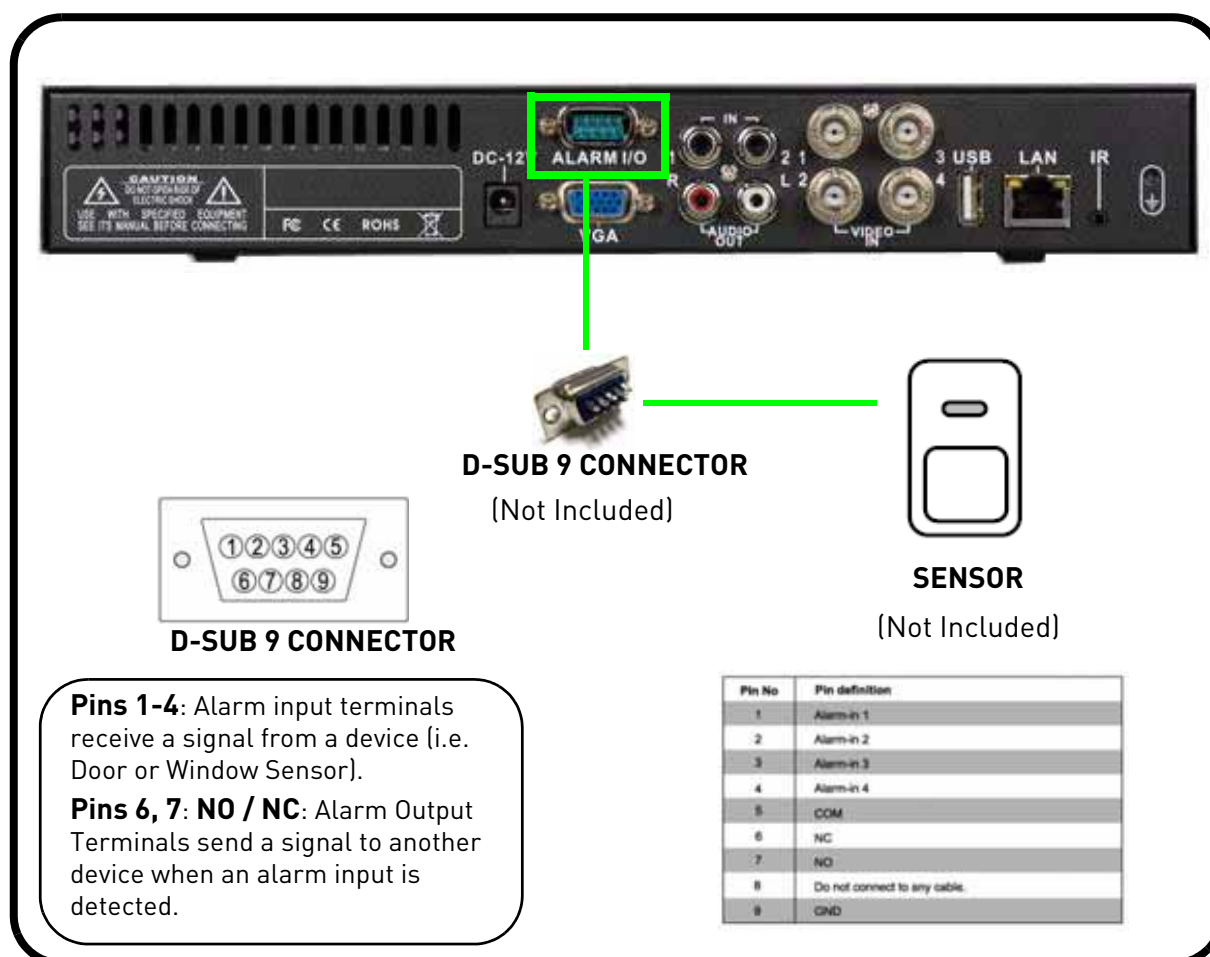

Installing a Sensor on EDGE⁺ series

You can connect external alarm input and alarm output devices to the system (i.e. motion sensors, door/window sensors). Use a motion detector or sensor to send a signal to the system to begin camera viewing and recording on the matching camera channel (when enabled in the Menu); simultaneously, the system sends an output signal to a device such as an alarm or siren.

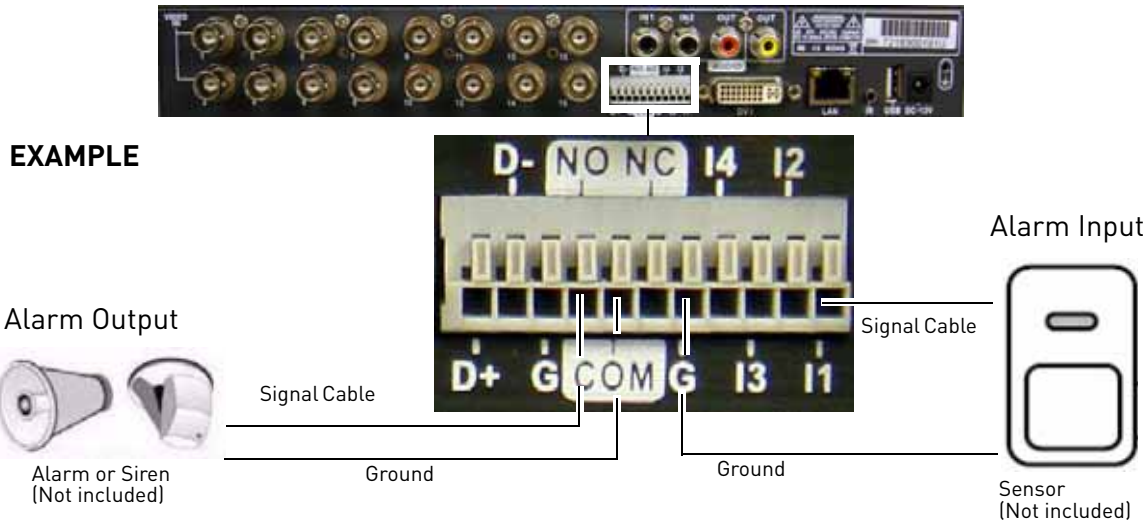

To connect an Alarm INPUT device to the system:

1. Connect the Signal Cable to the desired Channel number in the alarm block (I1 = Input 1, I2= Input 2 etc).
2. Connect the Ground cable to the Ground port (**G**) in the alarm block.

NOTE: The alarm block connectors are "push-type" connectors. To insert a wire, push the plastic tab with a small, rigid object, and simultaneously insert the wire. To release the wire, push the plastic tab and simultaneously pull the wire out.

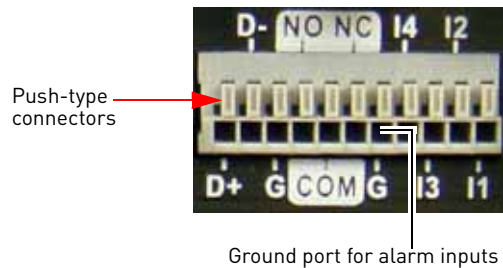

To ground multiple alarm input devices, "piggyback" the wires into the G (ground) port.

To connect an Alarm OUTPUT device to the system:

1. Connect the ground cable to the **COM** port.
2. Connect the signal cable to the **NO** (normally open) or **NC** (normally closed) port.

To configure alarm in devices:

1. From the Main Menu, click  to open the Alarm menu.
2. Use the Alarm Input & Output menu to configure alarm trigger settings.
 - For details, see "Alarm" on page 34.

Installing a PTZ (Pan, Tilt, Zoom) Camera on EDGE⁺ LH320 series

You can connect RS-485 PTZ cameras (not included) to the PTZ Control Block on the rear panel of the system (LH320 series only).

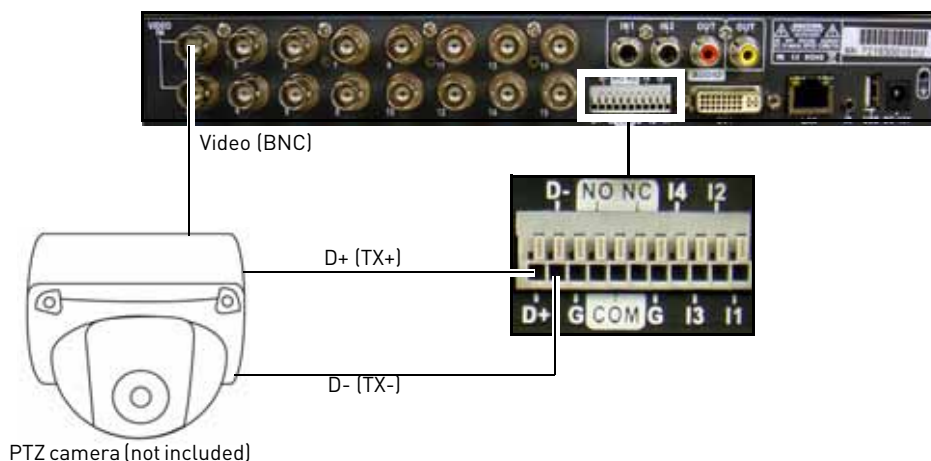

To install a PTZ camera:

1. Connect the Transmit Cable to the **D+ (TX+)** port of the PTZ block on the rear panel.
2. Connect the Receive Cable to the **D- (TX-)** port of the PTZ block on the rear panel.
3. Connect the video cable to a BNC port (usually channel 1).
4. Connect the power cable from the PTZ camera to a power outlet.

To configure the PTZ Camera's Baud Rate and DVR ID on the system:

1. From the Main Menu, click . The Camera menu opens.
2. Click **RS-485**.
3. Beside **Baud Rate**, adjust the values to match the baudrate of your PTZ camera.

NOTE: If installing multiple PTZ cameras, ensure all the PTZ cameras have the same baudrates. This system is capable of configuring a single baudrate only.

4. **OPTIONAL:** Beside **DVR ID** select the system's DVR ID number.

NOTE: DVR ID is used if you have a single PTZ camera that connects to multiple DVR's. Each DVR is assigned a DVR ID. Configuring the DVR ID allows the system to match itself with the PTZ camera.

To configure PTZ settings:

1. From the Main Menu, click . The Camera menu opens.
2. Click **RS-485**.
3. Click **PTZ Camera Setup**.
4. Click on the camera channel the PTZ camera is connected to.

5. Beside **Camera ID**, select the camera's system address. This number is shown when the PTZ camera first boots up.
 - This number may sometimes be called "Dome ID".
6. Click **Control Enable**, and use the mouse scroll wheel to select **0**.



7. Click **Protocol**, and use the mouse scroll-wheel to select the protocol of your PTZ camera.

PTZ Control Interface

To open the PTZ camera controls:

1. Click the channel with the PTZ camera.
2. Click the PTZ button () in the status bar.
 - The PTZ menu window opens. (PTZ camera required, not included, EDGE+ only).

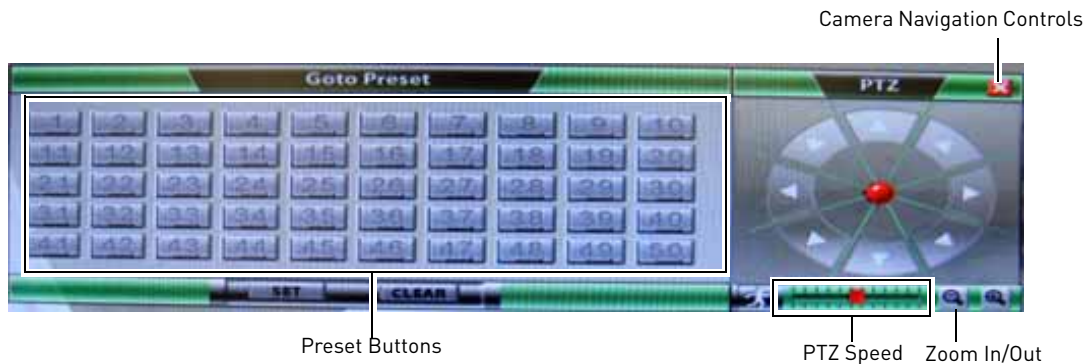

Controlling Pan, Tilt, Zoom

- To pan, tilt, or zoom the camera, drag the red circle in the navigation controls.
- Click the arrow buttons to pan and tilt the camera in small increments.
- Drag the Speed Slider to adjust the camera's pan and tilt speed.

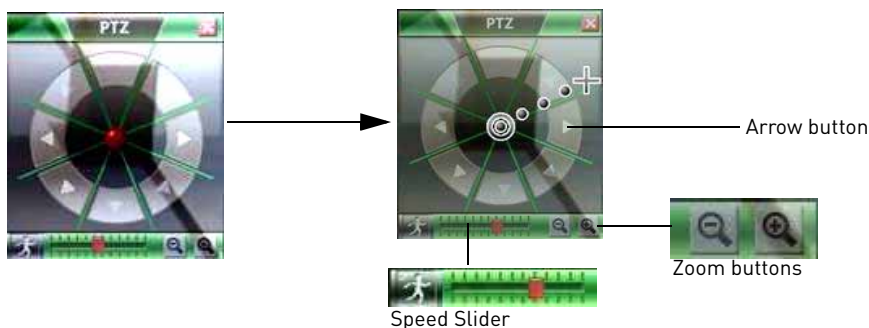

NOTE: You can also drag the cursor on the screen during full screen mode, to pan and tilt the camera.



Drag cursor on screen to pan/tilt the camera

Configuring PTZ Pre-sets

Saving a preset:

1. Pan, tilt, zoom the camera to the desired position.
2. Click the **SET** button.
3. Click on the desired Preset buttons (1~50) to save the preset.

Opening a preset:

1. Click on the desired preset button.
 - The camera automatically pans to the saved preset location.

Deleting a preset:

1. Click the **CLEAR** button.
2. Click on the desired preset you wish to delete.

APPENDIX C: CONNECTING AUDIO

You can listen to, and record live audio on the system one channel at a time.

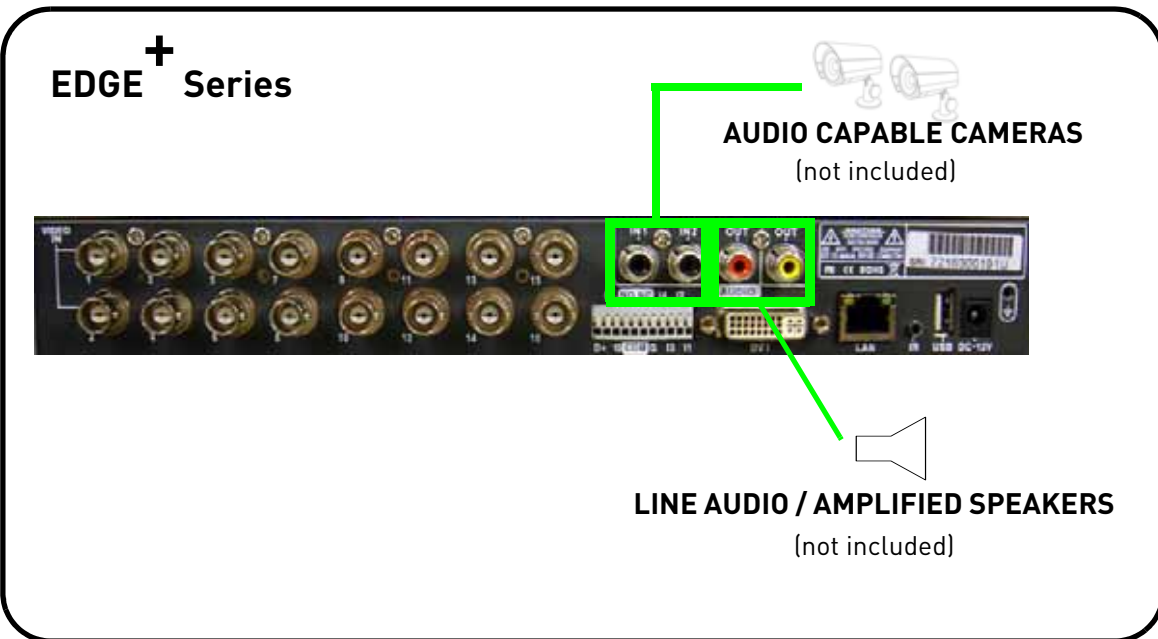
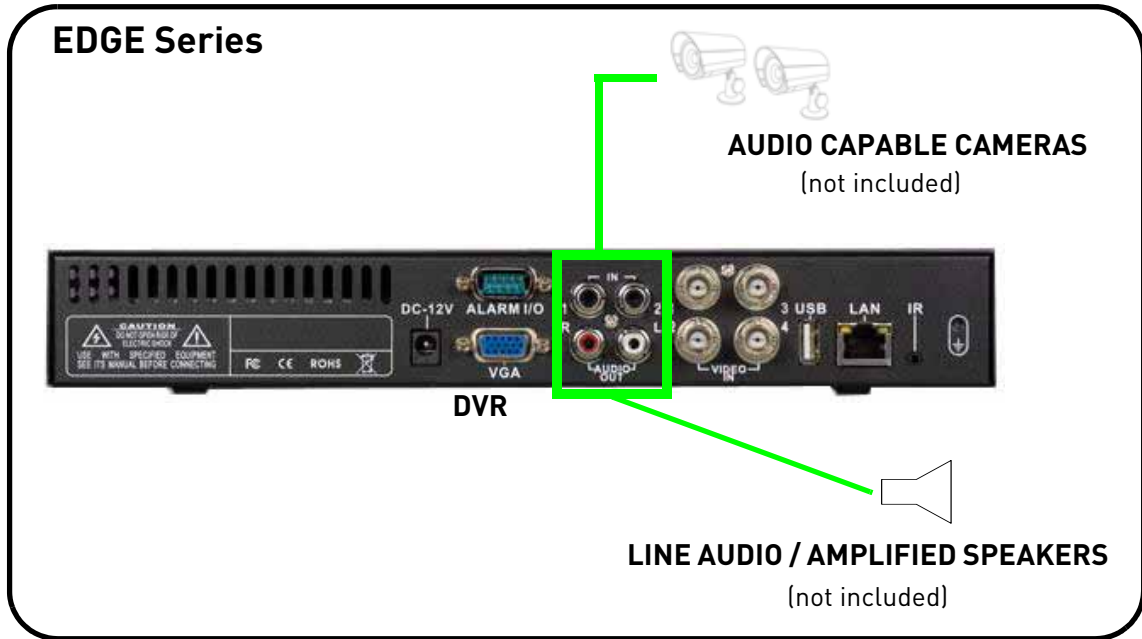

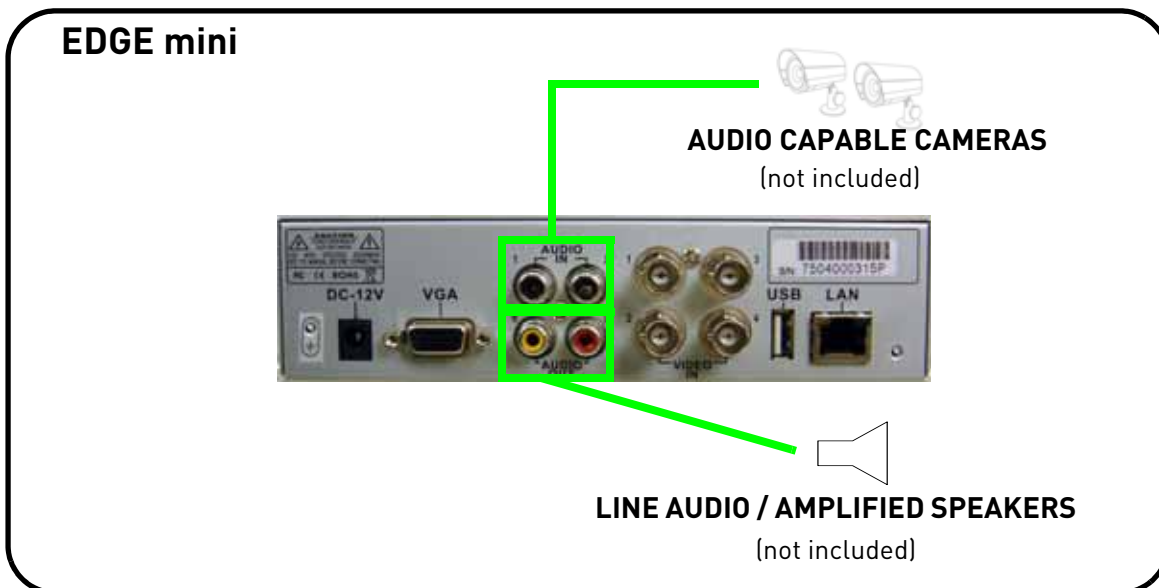

To connect audio:

1. Connect RCA audio cables from an audio capable camera(s) to the **AUDIO IN 1 / 2** ports on the rear panel.
2. Connect RCA audio out cables to the AUDIO OUT ports on the rear panel.

NOTE: The audio-out ports are two separate *mono* channels, *not* stereo left and right.

3. From the system Main Menu, click .
4. Click **Audio**, and then click under each camera and select either **O** to enable audio or **X** to disable audio.



- **Audio is available on channels 1 and 2 ONLY.**
- **To receive audio in your recordings, you MUST connect AUDIO CAPABLE cameras to the system.**

APPENDIX D: FULL CONNECTIVITY DIAGRAM

The following diagram outlines a general set of connections available with the system.

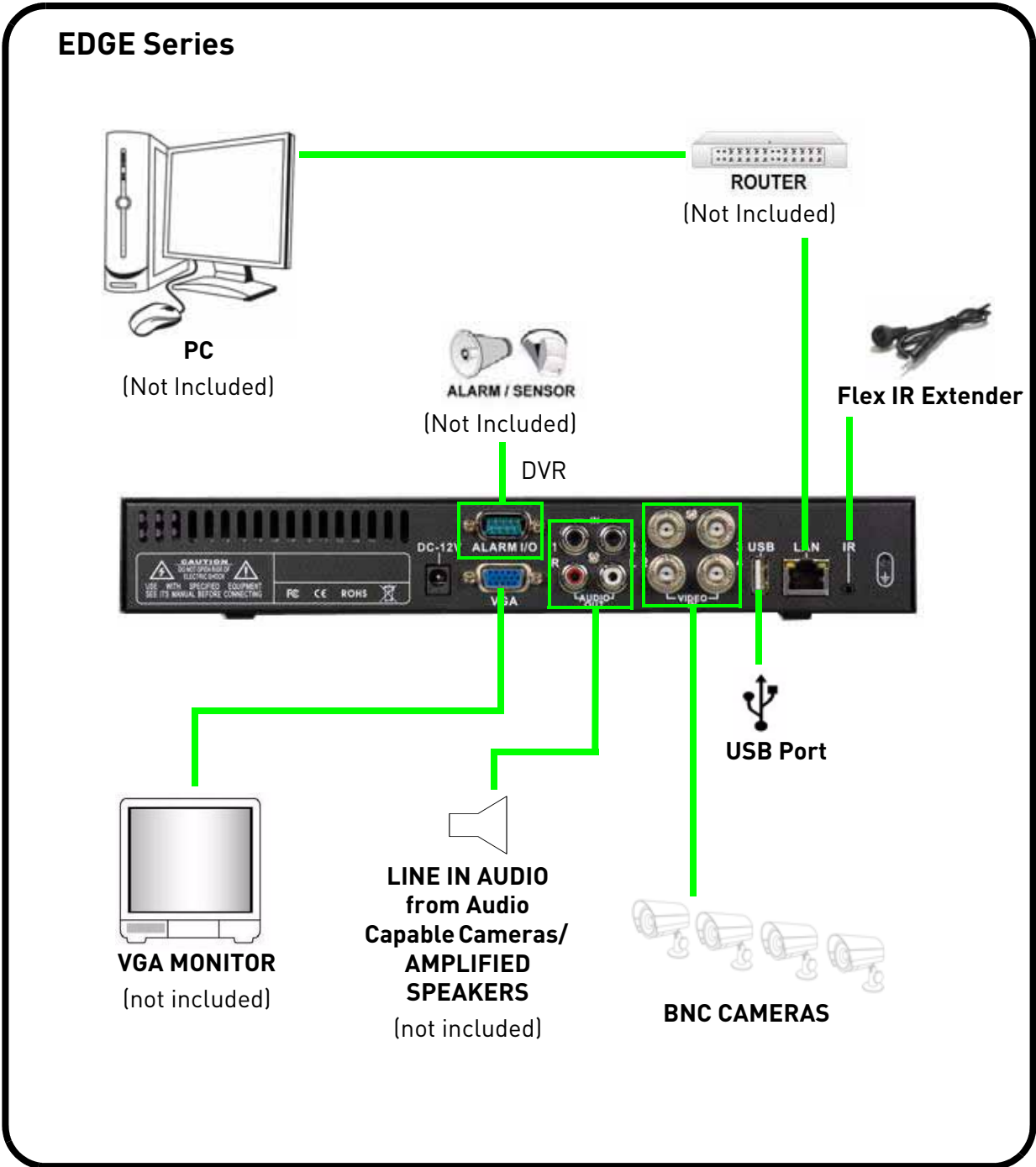

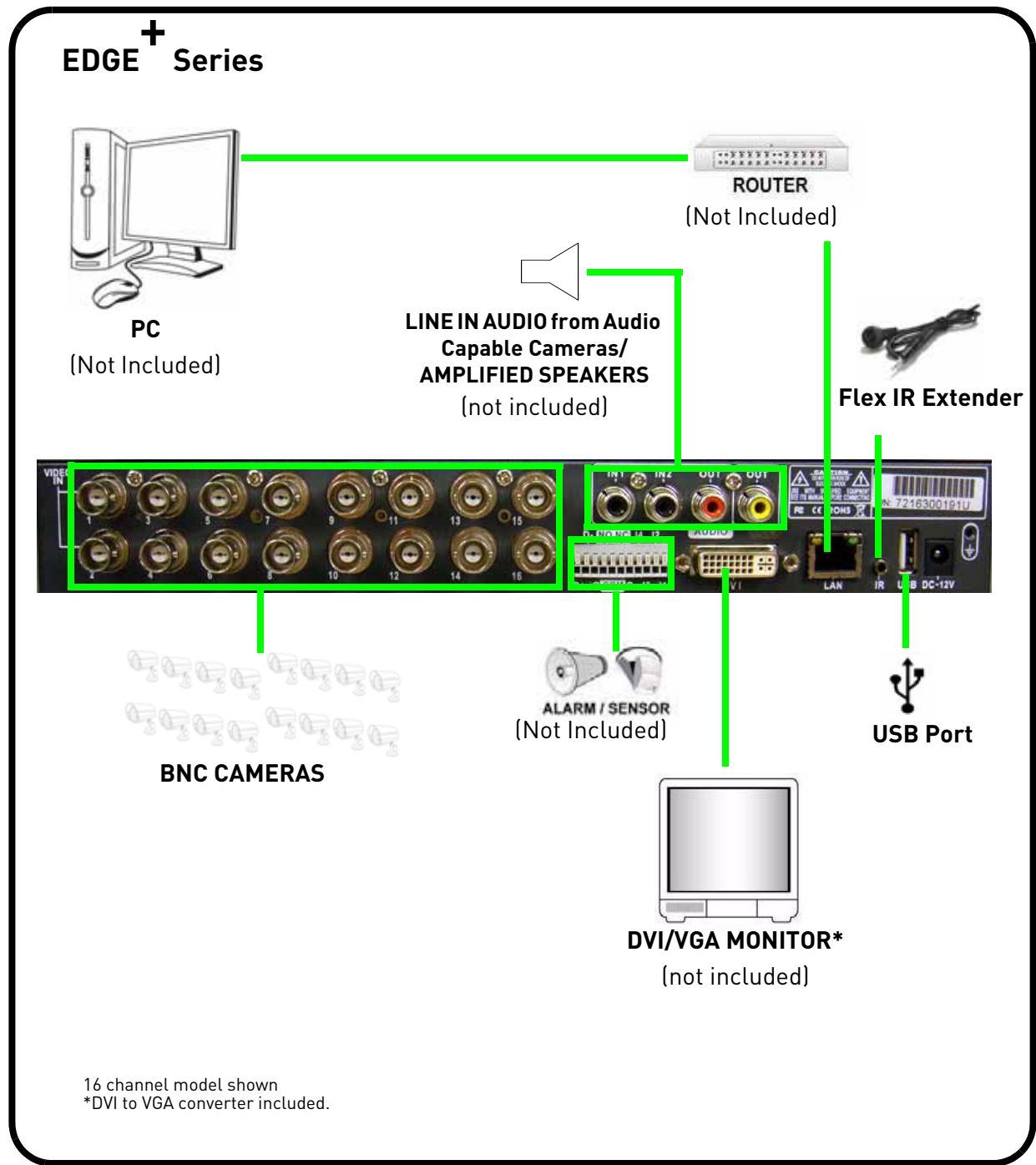

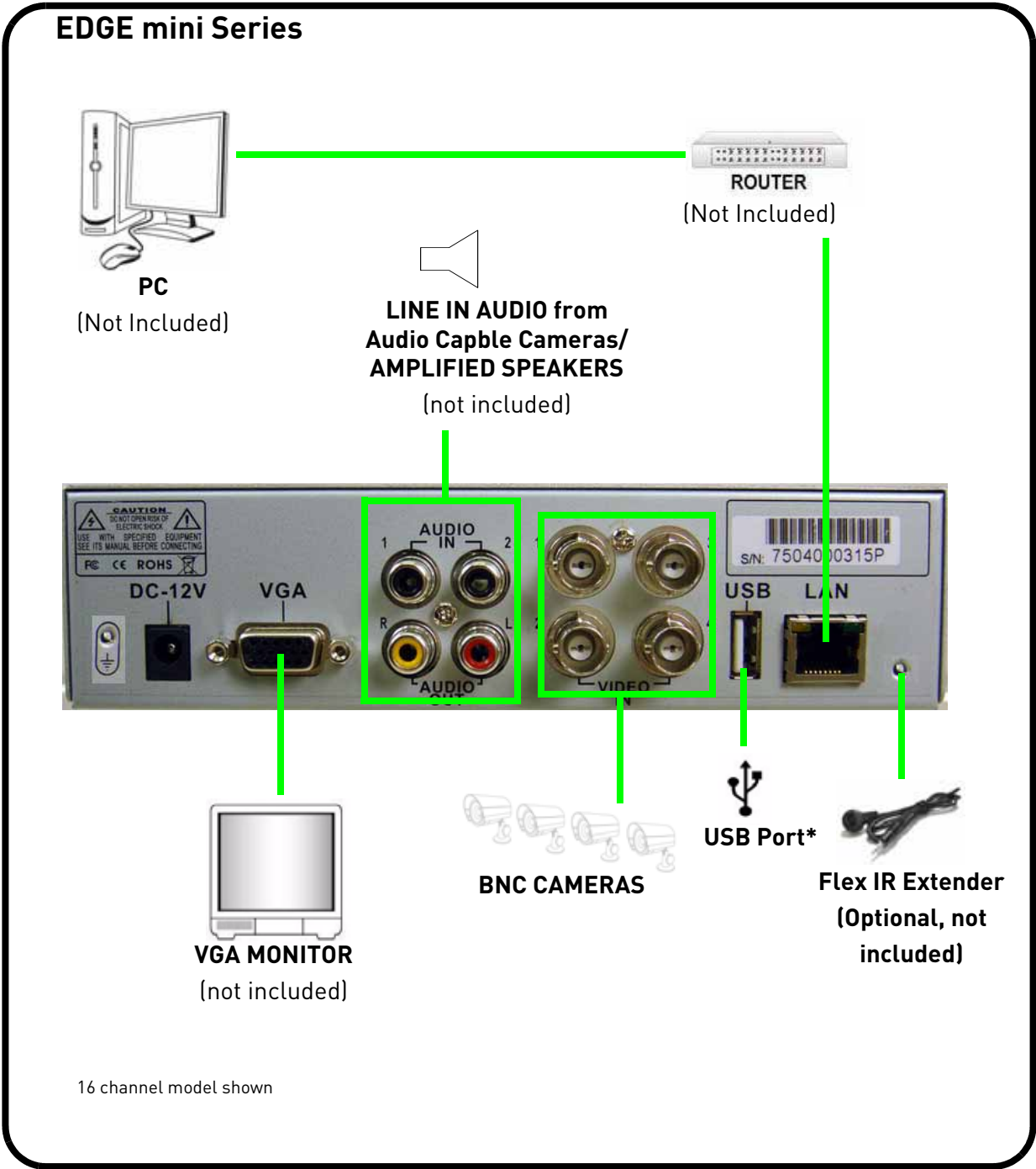

APPENDIX E: REPLACING THE HARD DRIVE

EDGE Series DVR

The system comes with a pre-installed 3.5" SATA hard drive. You can expand the system with a replacement single hard drive up to 2 terabyte (TB).

Make sure that the system is OFF and the power cable has been disconnected before changing the hard drive.

Removing the Hard Drive

To remove the hard drive:

1. Remove the screws from the top panel and side panels of the housing.
2. Gently slide the cover away from the front panel and lift off.
3. With your hand supporting the hard drive, turn the unit upside down. Remove the four mounting screws from the bottom of the unit. Turn the unit right side up.
4. Gently slide the hard drive toward the front panel and lift out.
5. Disconnect the power and data cables.

NOTE: Make sure to keep the two sets of screws (cover, mounting) in a safe place.

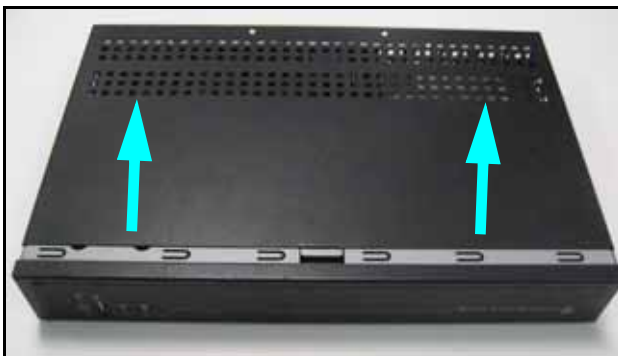

Figure 27.0 Slide cover away from front panel.



Figure 27.1 Remove cover.



Figure 27.2 Support the HDD with your hand and remove mounting screws.



Figure 27.3 Carefully remove the HDD from housing.

Replacing the Hard Drive

To replace the hard drive:

1. Firmly connect the power and data cables to the replacement SATA hard drive—each cable can only connect in one way.
2. Carefully place the hard drive in the housing: insert towards the front panel, lower the drive, then slide toward the rear panel.

NOTE: Make sure not to damage any of the cables when placing the hard drive in the housing.

NOTE: Make sure no cables are caught beneath the drive.

3. With your hand supporting the hard drive, turn the housing upside down: replace the four mounting screws on the bottom of the housing.
4. Turn the housing right side up. Replace the cover, making sure to slide the cover toward the front panel until flush.
5. Replace the screws on the top panel (x2) and side panels (x2).
6. Reconnect all cameras and cables. Re-mount the unit the back of your monitor if desired.
7. Power on the system. If you have installed a new hard drive, you must format the drive before using the system.

NOTE: The system will detect the hard drive a few seconds after powering on the system. The system will prompt you if the hard drive is not detected.

NOTE: You must format the new hard drive in order for the system to detect it. For details, see “Formatting the Hard Drive” on page 110.



Figure 27.4 Connect the power and data cables.



Figure 27.5 Insert the drive carefully



Figure 27.6 Replace the mounting screws

EDGE⁺ DVR

Make sure that the system is OFF and the power cable has been disconnected before changing the hard drive.

Removing the hard drive

To remove the hard drive:

1. Remove the screws from the top panel and side panels of the housing.

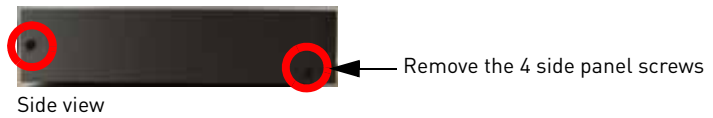
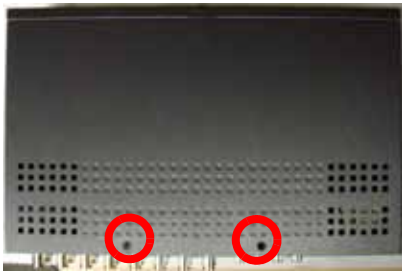

2. Gently slide the cover away from the front panel and lift off.
3. Remove the four screws that mount the hard drive to the metal bracket.

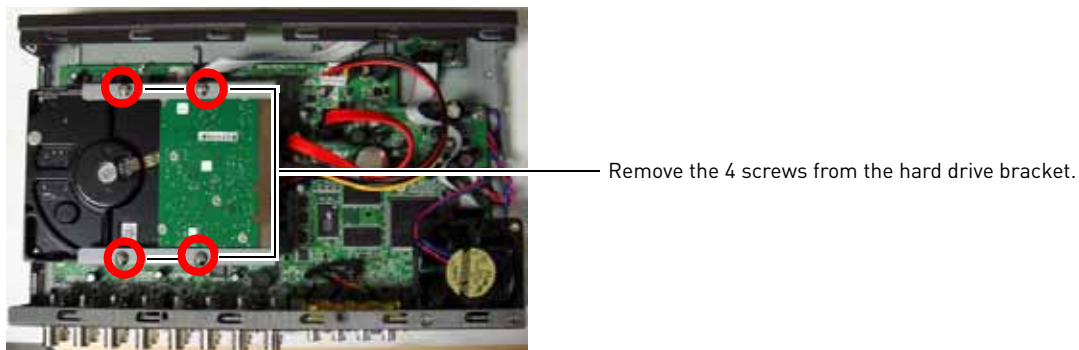

4. Gently slide the hard drive off of the mounting bracket.

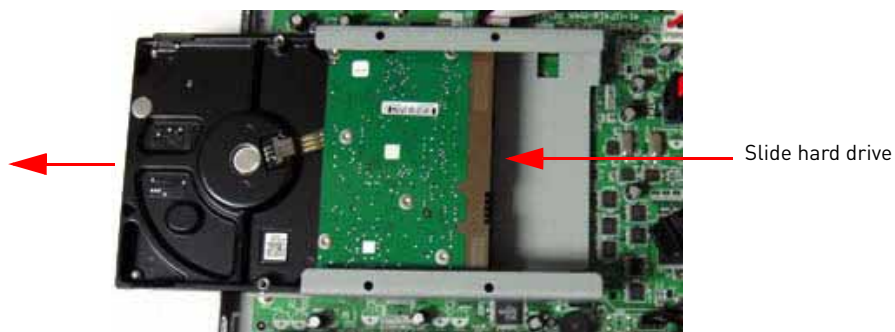

5. Disconnect the power and data cables.

Replacing the hard drive

To replace the hard drive:

1. Slide the new hard drive into the mounting bracket **upside down**.
2. Secure the hard drive to the mounting bracket using the four screws.

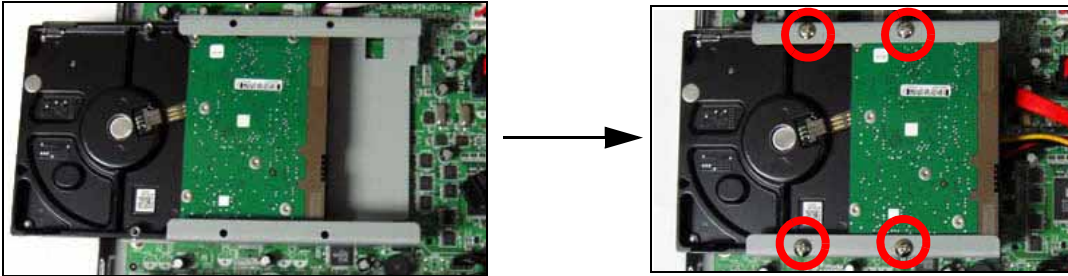

Mount the hard drive to the metal bracket using the four screws.

3. Firmly plug the SATA power and SATA data connector into the hard drive.



NOTE: You must format the new hard drive in order for the system to detect it. For details, see “Formatting the Hard Drive” on page 110.

EDGE Mini DVR

Make sure that the system is OFF and the power cable has been disconnected before changing the hard drive.

Removing the hard drive

To remove the hard drive:

1. Remove the screws on the side panels. Remove the single screw on the top and bottom panel of the system.

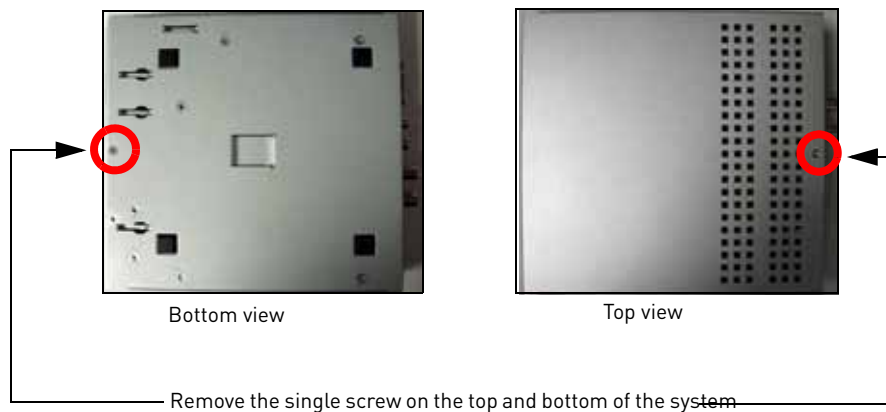
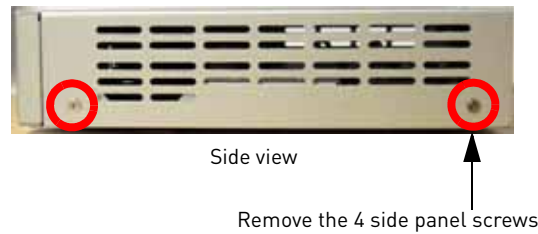

2. Carefully slide the cover off the system.
3. Remove the four screws that secure the hard drive to the mounting bracket.

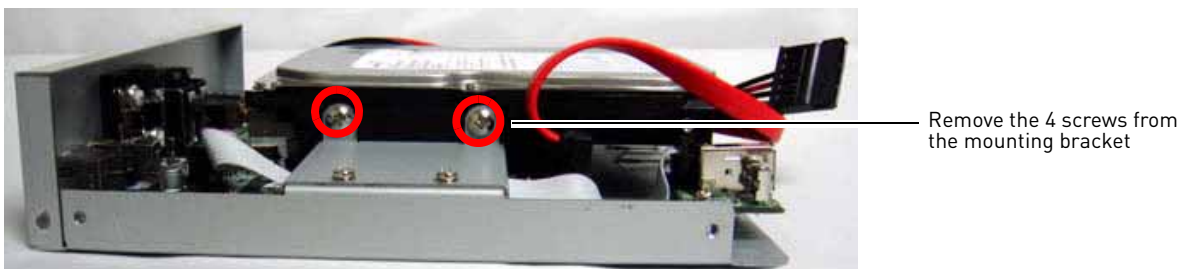

4. Remove the SATA data and power connectors.
5. Remove the hard drive from the mounting bracket.

Replacing the hard drive

To replace the hard drive:

1. Place the hard drive on the mounting bracket.

NOTE: Ensure the SATA data and power ports face the back panel.

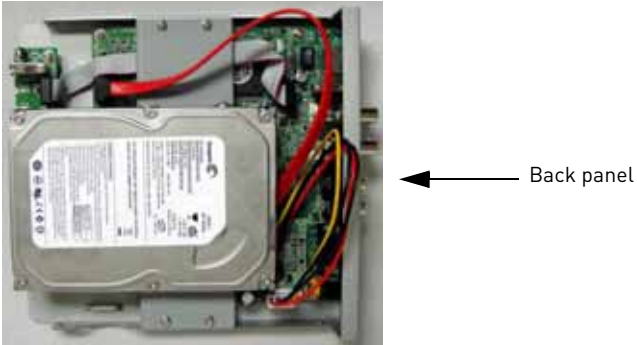

2. Plug in the SATA data and power connector.



3. Secure the hard drive to the mounting bracket with the four screws.

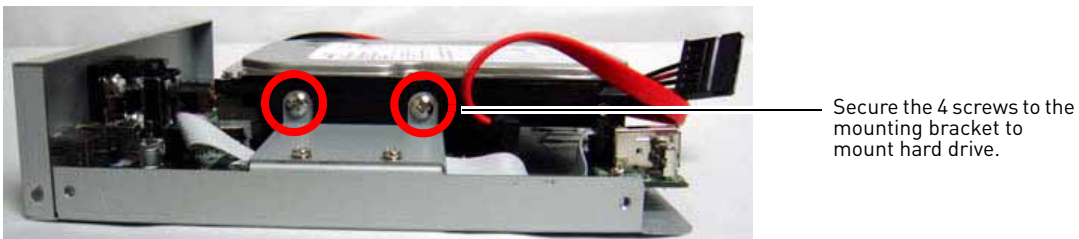

NOTE: You must format the new hard drive in order for the system to detect it. For details, see “Formatting the Hard Drive” on page 110.

Formatting the Hard Drive

If you replace the pre-installed hard drive, it *must* be formatted in order to function properly with the system.

ATTENTION: Formatting the HDD erases *all data* on the hard disk. *This step cannot be undone.*

To format the hard disk:

1. From the Main Menu, click . The Record menu opens.
2. Click **Format HDD**.
3. Click **Yes** to format the hard disk or click **No** to cancel.



Figure 27.7 Confirm formatting

Please allow a few moments for formatting to take place and the system to reset.

TROUBLESHOOTING

When a malfunction occurs, it may not be serious and can be corrected easily. The following describes the most common problems and solutions. Please refer to the following before calling Lorex Technical Support:

Error	Possible Causes	Solutions
<ul style="list-style-type: none"> System is not receiving power, or is not powering up 	<ul style="list-style-type: none"> Cable from power adapter is loose or is unplugged 	<ul style="list-style-type: none"> Confirm that all cables are connected correctly Confirm that the power adapter is securely connected to the back of the unit
	<ul style="list-style-type: none"> Cables are connected, but system is not receiving sufficient power 	<ul style="list-style-type: none"> Confirm that the system is powered on (LED indicators on the front should be ON) If the unit is connected through a power bar or surge protector, try bypassing the bar and connecting the power directly to the wall outlet Confirm that there is power at the outlet: <ul style="list-style-type: none"> Connecting the power cable to another outlet Test the outlet with another plugged device (such as an electric calculator or phone charger)
<ul style="list-style-type: none"> Remote control is not detected by the system 	<ul style="list-style-type: none"> Battery in the remote control is drained 	<ul style="list-style-type: none"> Install a fresh CR2025 battery in the remote control
	<ul style="list-style-type: none"> There are no batteries in the remote control 	
<ul style="list-style-type: none"> Hard drive is not detected by the system 	<ul style="list-style-type: none"> Hard drive cables are loose or not properly connected 	<ul style="list-style-type: none"> Remove the housing and check that hard drive cables are firmly connected
	<ul style="list-style-type: none"> There is no hard drive in the system 	<ul style="list-style-type: none"> Open the housing and install a 3.5" SATA hard drive
<ul style="list-style-type: none"> Hard drive is full (100%) and the unit is no longer recording 	<ul style="list-style-type: none"> Overwrite is not enabled 	<ul style="list-style-type: none"> From the Main Menu, select Record>Record Mode and select . This enables the system to continuously record by overwriting data once the hard drive is full

Troubleshooting (cont'd.)

Error	Possible Causes	Solutions
Mouse not detected by system	<ul style="list-style-type: none"> • Mouse cable is not firmly connected to the system 	<ul style="list-style-type: none"> • Firmly connect the mouse cable to the USB port on the rear panel.
	<ul style="list-style-type: none"> • Mouse is not connected to the system 	
	<ul style="list-style-type: none"> • System needs to be reset 	<ul style="list-style-type: none"> • Power off the system (disconnect power cable). Firmly connect a USB mouse to the USB port on the rear panel of the system. Reconnect the power cable to the DC 12V port on the rear panel.
<ul style="list-style-type: none"> • There is no picture on selected channels / camera picture is not being displayed 	<ul style="list-style-type: none"> • Camera cables are loose or have become disconnected 	<ul style="list-style-type: none"> • Check the camera video cable and connections • Disconnect and reconnect the cable at the system and at the camera • Try moving the camera to another channel or use another cable
<ul style="list-style-type: none"> • The image on the DVR appears, but does not have sound 	<ul style="list-style-type: none"> • Audio cables are loose or have been disconnected 	<ul style="list-style-type: none"> • Check the AUDIO connections to the DVR
	<ul style="list-style-type: none"> • Audio channels are disabled in the system menu 	<ul style="list-style-type: none"> • Check the Configurations: Main Menu>Record>Audio
	<ul style="list-style-type: none"> • Volume on external speakers (not included) is low or off 	<ul style="list-style-type: none"> • Increase volume on external speakers (not included)
New camera titles do not appear on the system (8/16-channel <i>only</i>)	<ul style="list-style-type: none"> • New camera titles have not been correctly saved on the system 	<ul style="list-style-type: none"> • Log in to DVR Netviewer in Internet Explorer • Click Setup and then click the Title tab • If you saved your old settings, click Load File; for new settings, enter the new camera titles and click Save file to save the settings to your PC • Disconnect and then reconnect the power cable from the rear panel of the system to reset and implement the new camera title settings
	<ul style="list-style-type: none"> • Camera display on the system is set to numerals 	<ul style="list-style-type: none"> • Check the Configurations: Main Menu>Camera>Camera Title Type
I am not receiving email notifications	<ul style="list-style-type: none"> • Email notification is disabled 	<ul style="list-style-type: none"> • Log in to DVR Netviewer in Internet Explorer and click Setup; click the Mail tab; under SMTP Status, select On
	<ul style="list-style-type: none"> • If using the default setting, you have not entered your Lorex DDNS user name and password 	<ul style="list-style-type: none"> • In the SMTP User field, enter your Lorex DDNS user name; in the SMTP Password field, enter your Lorex DDNS password (you must first register for Lorex DDNS to use email notification at the default setting)
	<ul style="list-style-type: none"> • Default setting is disabled, but you have not entered your own SMTP information 	<ul style="list-style-type: none"> • If you want to use your own SMTP server, deselect the Default box, and enter your SMTP Server address, Port, User name, and Password in the respective fields



LOREX PRODUCT LIMITED WARRANTY

LOREX warrants, to the original retail purchaser only (the "Purchaser"), that this item (the "Product") if properly used and installed, and where applicable, the CD-ROM on which the accompanying software is provided, is free from manufacturing defects in material and workmanship, provided the Product is used in normal conditions and is installed and used in strict accordance with the instructions contained.

This warranty shall be in force for the following warranty periods (the "Warranty Period"), commencing on the date the Purchaser buys the Product at retail in an unused condition.

Parts and Labor: 1 year (Warranted parts do not include Bulbs, LED's and Batteries)

LOREX's obligations under this warranty shall be limited to

- The repair and or replacement of the product by means of hardware and/or software (at option of LOREX);
 - The replacement of any warranted parts found by LOREX to be defective in the Product or, in LOREX's sole discretion, the replacement of the Product found by LOREX to be defective.
 - If LOREX is unable to repair or replace the Product or CD-ROM, refund the then-current value of the Product.
- Any replacement parts furnished by LOREX in connection with this warranty shall be warranted to the Purchaser for a period equal to the unexpired portion of Warranty Period for the Product.

Warranty Exclusions

This warranty does not apply to Bulbs, LED's and Batteries supplied with or forming part of the product. This warranty is invalidated if other than LOREX accessories are or have been used in or in connection with the Product or in any modification or repair is made to the Product by other than a service depot authorized by LOREX. This warranty does not apply to defects or damages arising by use of the Product in other than normal (including normal atmospheric, moisture and humidity) conditions or by installation or use of the Product other than in strict accordance with the instructions contained in the Product's Owner's Manual.

This warranty does not apply to defects in or damages to the Product caused by (i) negligent use of the Product, (ii) misuse, abuse, neglect, alteration, repair or improper installation of the Product, (iii) electrical short circuits or transients, (iv) Purchaser usage not in accordance with product installation, (v) use of replacement parts not supplied by LOREX (vi) improper Product maintenance, or (vii) accident, fire, flood or other Acts of God.

This warranty does not cover the performance or functionality of any computer software included in the package with the Product. This warranty only covers defects in the CD-ROM media such as a broken or a defect in the CD-ROM that would prevent the CD-ROM from being read by your personal computer's CD-ROM drive. LOREX makes no warranty that the software provided with the Product will function without interruption or otherwise be free of anomalies, errors or "Bugs". LOREX makes no warranty with regard to any software provided with the Product unless specifically set forth otherwise in a license agreement accompanying such software. This warranty does not cover any costs relating to removal or replacement of any Product, CD-ROM, or software installed on your computer.

LOREX reserves the right to make changes in design or to make additions to or improvements in its products without incurring any obligation to modify any product which has already been manufactured. LOREX will make every effort to provide updates and fixes to its software via its website. This warranty does not cover any alteration or damage to any other software that may be or may become resident on the user's system as a result of installing the software provided. This warranty is in lieu of other warranties, express or implied, and LOREX neither assumes nor authorizes any person to assume for it any other obligation or liability in connection with the sale or service of the Product. In no event shall LOREX be liable for any special or consequential damages arising from the use of the Product or arising from the malfunctioning or non-functioning of the Product, or for any delay in the performance of this warranty due to any cause beyond its control.

This warranty shall not apply to the appearance or accessory items including, but not limited to cabinets, cabinet parts, knobs etc., and the uncrating, setup, installation or the removal and reinstallation of products after repair.

LOREX does not make any claims or warranties of any kind whatsoever regarding the Product's potential, ability or effectiveness to prevent minimize, or in any way affect personal or property damage or injury. LOREX is not responsible for any personal damage, loss or theft related to the Product or to its use for any harm, whether physical or mental related thereto. Any and all claims or statements, whether written or verbal, by salespeople, retailers, dealers or distributors to the contrary are not authorized by LOREX, and do not affect this provision of this warranty.

LOREX's responsibility under this, or any other warranty, implied or expressed, is limited to repair, replacement or refund, as set forth above. These remedies are the sole and exclusive remedies for any breach of warranty. LOREX is not responsible for direct, special, incidental, or consequential damages resulting from any breach of warranty or under any other legal theory including but not limited to, loss profits, downtime, goodwill, damage to or replacement of equipment and property and any costs of recovering, reprogramming or reproducing any program or data stored in or used with a system containing the Product CD-ROM or accompanying software.

LOREX does not warrant that the software will operate with any other software except that which is indicated. LOREX cannot be responsible for characteristics of third party hardware or software which may effect the operation of the software included.

The purchaser may have other rights under state, provincial, or federal laws and where the whole or part of any item of this warranty is prohibited by such laws, it shall be deemed null and void, but the remainder of the warranty shall remain in effect.

All expressed and implied warranties are limited in duration to the limited warranty period. No warranties apply after that period. Some states do not allow limitation on how long an implied warranty lasts, so this limitation may not apply to you. Some states do not allow the exclusion or limitation of incidental or consequential damages, so the above warranty may not apply to you. This limited warranty gives you specific legal rights and you may also have other rights that vary from state to state.

Obtaining Service

In order to obtain service, please make sure that you have registered your product on-line (www.lorexcvt.com) in the warranty registration section. Should the Product require service under this warranty, the Purchaser must provide LOREX with a copy of his/ her original, dated bill of sale; receipt or invoice, failing which LOREX will not perform any of its obligations under this warranty. If you return the Product and/or CD-ROM to LOREX, you must assume the risk of damage or loss during shipment. You must use the original packaging or the equivalent, and you must pay postage.

To claim on this warranty, proceed with the following steps:

- 1 Pack the Product in a well-padded sturdy carton.
 2. If the unit was purchased in the United States proceed as follows:
 - a. Please contact our customer service department to obtain a return authorization number.
 - b. Return the unit to:

LOREX Returns
c/o Russell Farrow
15 Lawrence Bell Drive, Amherst, NY 14221
 - ii. If the unit was purchased in Canada proceed as follows:
 - a. Please contact our customer service department to obtain a return authorization number.
 - b. Return the unit to:

LOREX Service Center,
250 Royal Crest Court, Markham, Ont. L3R 3S1
 - iii) If the unit was purchased in Europe please visit:

www.lorexinternational.com for return instructions.
- TOLL FREE CUSTOMER SUPPORT**
North America: 1-888-42-LOREX (1-888-425-6739)
Local: 905-940-5355
International: 800-42-LOREX 0 (800-425-67390)
www.lorexcvt.com

Always use discretion when installing video and/or audio surveillance equipment especially when there is perceived privacy. Inquire regarding federal, state and/or local regulations applicable to the lawful installation of video and or audio recording or surveillance. Party consent may be required.

GARANTIE LIMITÉE DES PRODUITS LOREX

LOREX garantit à l'acheteur original (ci-après désigné comme étant "l'acheteur") dans un magasin au détail seulement, et que ce produit (ci-après désigné comme étant le "produit"), s'il est installé correctement et - s'il y a lieu - utilisé conformément aux instructions ci-incluses, et le disque CD-ROM qui comporte le logiciel, seront libres de tout défaut de fabrication, tant dans les pièces que la main-d'oeuvre, pourvu que le produit soit utilisé dans des conditions normales et installé et utilisé strictement selon les instructions incluses dans le guide qui l'accompagne.

Cette garantie couvrira la période mentionnée ci-dessous (ci-après désignée comme étant la "période de garantie"), commençant le jour où l'acheteur se procure le produit à l'état neuf dans un magasin au détail.

Pièces et main-d'oeuvre :

1 année (les pièces couvertes n'incluent pas les ampoules, voyants à DEL ni les piles).

Les obligations de LOREX selon les termes de cette garantie se limitent exclusivement aux points suivants :

- LOREX se réserve le droit de réparer ou de remplacer, sa seule discrétion, le logiciel et/ou le matériel.
 - Le remplacement des pièces sous garantie que LOREX estime être défectueuses dans le produit ou le disque CD-ROM ou, à sa seule discrétion, le remplacement du produit jugé défectueux.
 - Si LOREX ne peut réparer ni remplacer le produit ou le disque CD-ROM, rembourser la valeur monétaire du produit ou du disque CD-ROM en cours au moment de l'achat.
- Toutes les pièces remplacées par LOREX seront couvertes pendant la période résiduelle de la garantie dudit produit.

Exclusions de la garantie

Pour obtenir du service, veuillez vous assurer que vous avez inscrit votre produit en ligne (www.lorexcvt.com) dans la section d'abonnement à la garantie. Cette garantie ne couvre pas les ampoules, voyants à DEL ni les piles incluses avec le produit ou faisant partie de celui-ci.

Cette garantie deviendra nulle si des accessoires autres que ceux vendus ou distribués par LOREX sont utilisés ou ont été utilisés conjointement avec le produit ou si des modifications ou des réparations ont été effectuées au produit par une entité autre qu'un centre de service autorisé par LOREX.

Cette garantie ne s'applique pas aux défauts ni aux dommages survenus suite à une utilisation anormale du produit (incluant des conditions atmosphériques et des taux d'humidité anormaux) ou suite à une installation ou une utilisation du produit autre que celle décrite dans le guide accompagnant le produit.

Cette garantie ne s'applique pas aux défauts ni aux dommages causés au produit suite à (i) une utilisation insouciante du produit, (ii) mauvaise utilisation, abus, négligence, modification ou mauvaise installation du produit, (iii) court-circuits ou transitoires électriques, (iv) tout usage de l'acheteur qui ne correspond pas à l'installation prescrite du produit, (v) l'utilisation de pièces non fournies par LOREX, (vi) un entretien inadéquat du produit, ou (vii) tout accident, incendie, inondation ou autres désastres naturels.

Cette garantie ne couvre pas la performance ni la fonctionnalité de tout logiciel informatique inclus avec le produit. Cette garantie ne couvre pas les défauts que pourrait contenir le support optique (disque CD-ROM) ou magnétique (disquette), tel qu'un CD-ROM brisé ou comportant un défaut qui empêcherait d'être lu adéquatement par le lecteur de disque de votre ordinateur. LOREX ne garantit pas que le logiciel fourni avec le produit fonctionnera sans interruption ni qu'il sera libre de tout défaut, d'erreurs ou de bogues. LOREX ne garantit pas le logiciel inclus à moins que cela ne le soit mentionné spécifiquement dans l'entente de la licence incluse avec le produit. Cette garantie ne couvre pas les frais se rapportant à l'enlèvement ni à la réinsertion de tout produit, logiciel, périphérique ou disque CD-ROM installé sur votre ordinateur.

LOREX se réserve le droit de modifier la conception ou d'apporter des ajouts ou des améliorations à ses produits, sans obligation de sa part de modifier les produits déjà fabriqués. LOREX fera tout en son pouvoir pour fournir des améliorations et des réparations à son logiciel via son site web. Cette garantie ne couvre pas les altérations ni les dommages effectués tout autre logiciel, ni les bogues pouvant résider de la part de l'utilisateur sur le système de l'utilisateur suite à l'installation du logiciel ci-inclus.



Cette garantie a présance sur toutes les autres garanties tacites ou explicites, incluant la garantie en qualité loyale et marchande et les aptitudes visant toute autre obligation ou responsabilité de la part de Lorex, et par les présentes, Lorex n'autorise aucune personne ni entité à assumer pour elle nulle autre responsabilité en rapport avec la vente de ce produit. Lorex ne sera pas tenue responsable, en aucune circonstance, des dommages-intérêts directs ou indirects survenant de l'utilisation du produit ou suite au mauvais fonctionnement ou à l'absence de fonctionnement dudit produit, ainsi que pour tout délai dans l'exécution de cette garantie suite à des circonstances hors du contrôle de Lorex.

Lorex ne garantit d'aucune manière l'apparence extérieure du produit, ni les pièces ou accessoires incluant, mais ne s'y limitant pas, le boîtier, les pièces du boîtier, les boutons, etc., ainsi que le déballage, l'installation, l'enlèvement et la réinstallation du produit après une réparation.

Lorex ne garantit pas et ne fait aucune revendication de ce qui a trait au potentiel, à la capacité ou l'efficacité de prévenir, réduire ou d'une façon quelconque, d'influer sur les dommages à la propriété privée ou sur les blessures corporelles. Lorex ne sera pas tenue responsable des blessures corporelles, dommages à la propriété personnelle, perte ni au vol se rapportant de près ou de loin au produit ou son usage dans un cadre malveillant, qu'il soit physique ou mental. Lorex n'autorise aucunement les représentants, détaillants ou grossistes, à faire des revendications ou des annonces de la part de Lorex, tant par voie écrite que verbale et ces annonces n'influent d'aucune manière sur les clauses de cette garantie.

La seule responsabilité de Lorex, selon les termes de cette garantie, qu'ils soient tacites ou explicites, se limite à une réparation, un remplacement ou un remboursement, selon les clauses décrites dans les présentes. Ces recours constitueront les seuls auxquels a droit l'acheteur pour les bris des clauses de la garantie. Lorex ne sera pas responsable des dommages-intérêts spéciaux, directs ou indirects, qui résulteraient d'un bris des clauses de cette garantie ou de toute autre convention législative, incluant mais ne s'y limitant pas, les pertes de profits, pertes de courants immobilisant des équipements, la valeur ajoutée des biens incorporels, les dommages effectués au produit et à la propriété ou les coûts reliés à leur remplacement, ainsi que les frais de recouvrement, reprogrammation ou reproduction d'un programme ou des données stockées dans un système contenant le disque CD-ROM du produit ou le logiciel qui accompagne celui-ci.

L'acheteur peut bénéficier de certains droits provinciaux ou fédéraux additionnels et toute clause de cette garantie qui soit prohibée par de tels lois sera jugée nulle et sans effet mais les autres clauses demeureront en vigueur.

Lorex ne garantit pas que ce logiciel fonctionnera conjointement avec tout autre logiciel ou suite logicielle, moins que cela ne soit indiqué. Lorex ne sera pas tenue responsable des caractéristiques ni des fonctions du matériel ou des logiciels d'un tiers pouvant entrer en conflit avec le fonctionnement du logiciel ci-inclus.

Toutes les garanties tacites ou explicites se limitent à la durée de la garantie limitée. Aucune garantie ne sera applicable après cette période de temps. Certains états ou provinces ne permettent pas de restrictions en ce qui a trait aux termes d'une garantie tacite, ni d'exclusions aux dommages-intérêts directs ou indirects et il se peut que ces restrictions ne s'appliquent pas à vous. Cette garantie donne à l'acheteur original des droits spécifiques et il se peut que d'autres droits, variant d'un état ou d'une province à l'autre, puissent lui être conférés.

Obtention du service

Si l'acheteur a besoin de service pour son produit, selon les termes de cette garantie limitée, il doit fournir à Lorex une copie de la facture d'achat affichant clairement la date et l'endroit où le produit a été acheté. Sans cette preuve d'achat, Lorex ne sera pas dans l'obligation de remplir ses obligations envers l'acheteur. Si vous retournez le produit et/ou le disque CD-ROM à Lorex, vous devez assumer le risque que ceux-ci soient endommagés ou perdus au cours de l'expédition. Vous devez emballer le produit dans sa boîte originale ou un emballage adéquat et vous devez défrayer les coûts d'expédition à l'une des adresses mentionnées ci-dessous.

Pour bénéficier du service sous garantie, vous devez suivre les étapes ci-dessous :

1. Emballez le produit dans une boîte solide et remplie de matériau d'expédition.
2. i) Si l'appareil a été acheté aux États-Unis, suivez ces étapes-ci :
 - a. Veuillez contacter notre département de service à la clientèle pour obtenir un numéro d'autorisation pour le retour.
 - b. Retournez le produit à :
Lorex Returns
c/o Russell Farrow
15 Lawrence Bell Drive, Amherst, NY 14221

ii) Si l'appareil a été acheté au Canada, suivez ces

étapes-ci :

- a. Veuillez contacter notre département de service à la clientèle pour obtenir un numéro d'autorisation pour le retour.

b. Retournez le produit à :
Lorex Customer Service
250 Royal Crest Court, Markham, ON L3R 3S1

iii) Si l'unité a été achetée dans Europe veuillez visiter : www.lorexinternational.com pour les instructions de retour

COMPOSEZ LA LIGNE D'ASSISTANCE SANS FRAS A US CONOMMATEURS:

L'Amérique du nord: 1-888-42-LOREX (1-888-425-6739)

Local : 905-940-5355

International : 800-42-LOREX 0 (800-425-67390)

Soyez toujours très discret lorsque vous installez des systèmes de surveillance, surtout dans les endroits plus intimes. Informez-vous au sujet des lois et règlements municipaux, provinciaux ou fédéraux qui s'appliquent à l'installation d'appareils de surveillance audio et vidéo. Il se peut que le consentement de la partie surveillée soit exigé.

GARANTIE LIMITADA DEL PRODUCTO LOREX

Lorex garantiza, sólo al comprador original al por menor (el "Comprador") que este artículo (el "Producto"), si se usa e instala debidamente, y – si hay lugar – el CD-ROM en el que se proporciona el software asociado, está libre de defectos de fabricación en materiales y mano de obra, sujeto a que el Producto sea usado en condiciones normales y que sea instalado y usado estrictamente de acuerdo con las instrucciones contenidas.

Esta garantía será para los siguientes periodos de garantía (el "Período de Garantía"), a partir de la fecha en que el Comprador adquiere el Producto al por menor en la condición de no haber sido usado previamente.

Repuestos y Mano de Obra: 1 año (Las piezas garantizadas no incluyen bombillas, LEDs y baterías)
Las obligaciones de Lorex bajo esta garantía estarán limitadas a:

- la reparación o el reemplazo del producto por medio de hardware y/o software (a opción de Lorex).
- el reemplazo de cualquier parte garantizada que Lorex determine que está defectuosa en el Producto o CD-ROM o, por decisión única de Lorex, al reemplazo del Producto que Lorex encuentre defectuoso.
- Si a Lorex no le es posible reparar o reemplazar el Producto o el CD-ROM, se devolverá el valor vigente en ese momento del Producto o CD-ROM.

Se garantizará al Comprador cualquier pieza de repuesto provista por Lorex en conexión con esta garantía por un período igual a la parte no vencida del Período de Garantía del Producto.

Exclusiones de la garantía

Esta garantía no se aplica a las bombillas, LEDs y baterías suministradas con el producto o que formen parte del mismo.

Esta garantía quedará nula si se han usado accesorios que no son Lorex en el Producto o en relación con el mismo o si se hace alguna modificación o reparación al Producto en algún taller que no sea un local de servicio autorizado por Lorex.

Esta garantía no se aplica a defectos o daños resultantes del uso del producto en condiciones diferentes a las normales (incluyendo condiciones atmosféricas o de humedad normales) o por la instalación o uso del Producto en forma distinta a seguir estrictamente las instrucciones contenidas en el Manual del Propietario del Producto.

Exclusiones de la garantía

Esta garantía no se aplica a las bombillas, LEDs y baterías suministradas con el producto o que formen parte del mismo.

Esta garantía quedará nula si se han usado accesorios que no son Lorex en el Producto o en relación con el mismo o si se hace alguna modificación o reparación al Producto en algún taller que no sea un local de servicio autorizado por Lorex.

Esta garantía no se aplica a defectos o daños resultantes del uso del producto en condiciones diferentes a las normales (incluyendo condiciones atmosféricas o de humedad normales) o por la instalación o uso del Producto en forma distinta a seguir estrictamente las instrucciones contenidas en el Manual del Propietario del Producto.

Esta garantía no se aplica a defectos o daños al Producto causados por (i) uso negligente del Producto, (ii) mal uso, abuso, negligencia, alteración, reparación o instalación incorrecta del Producto, (iii) cortocircuitos o corrientes eléctricas transitorias, (iv) uso por el Comprador que no está de acuerdo con la instalación del producto, (v) uso de piezas de repuesto no suplidas por Lorex (vi) inadecuado mantenimiento del Producto, o (vii) accidente, incendio, inundación u otros accidentes naturales.

Esta garantía no cubre el rendimiento o funcionalidad de ningún software de computadora incluido en el paquete con el Producto. Esta garantía sólo cubre defectos en el material de CD-ROM, tal como roturas o defectos en el CD-ROM que impida que sea leído por la unidad de CD-ROM de su computadora personal. Lorex no garantiza que el software provisto con el Producto funcione sin interrupción o que de otra forma esté libre de anomalías, errores o "bugs". Lorex no ofrece ninguna garantía con respecto a algún software provisto con el equipo a menos que específicamente se establezca de otra forma en un acuerdo de licencia que acompañe a dicho software.

Esta garantía no cubre ningún costo relativo a la remoción o reemplazo de algún Producto, CD-ROM, o software instalado en su computadora.

Lorex se reserva el derecho de hacer cambios en el diseño o hacer adiciones o mejoras a sus productos sin incurrir en ninguna obligación de modificar algún producto que ya haya sido fabricado.

Lorex tratará en lo posible de proporcionar actualizaciones y arreglos a su software por medio de su página en la red.

Esta garantía no cubre ninguna alteración ni daño a algún otro software que pueda ser instalado o pueda quedar instalado en el sistema del usuario como resultado de la instalación del software provisto.

Esta garantía es el reemplazo de otras garantías, expresas o implícitas, y Lorex no asume ni autoriza a ninguna persona a asumir por ella ninguna obligación en relación con la venta o servicio del producto. En ningún caso Lorex será responsable por ningún daño o perjuicio especial o consecuente resultante del uso del Producto o de su mal funcionamiento o incapacidad de funcionar, o por cualquier demora en la atención de esta garantía debida a causas fuera de su control.

Esta garantía no se aplicará a la apariencia o artículos accesorios incluyendo, sin esiar limitado a ellos, gabinetes, piezas de gabinetes, perillas, etc., y el desembalaje, instalación, configuración, o remoción y reinstalación del producto después de ser reparado.

Lorex no hace ninguna de cada declaración ni garantía de ninguna clase con respecto al potencial, capacidad o eficacia del Producto para evitar, minimizar o en alguna forma atectar a los daños o lesiones personales o a la propiedad. Lorex no es responsable por ningún daño personal, siniestro o robo relacionado con el Producto o a su uso para cualquier daño, sea físico o mental relacionado con el mismo. Cualquier afirmación o declaración, sea escrita o verbal, hecha por vendedores, minoristas o distribuidores en sentido contrario no es autorizada por Lorex y no afecta esta disposición de esta garantía.

La responsabilidad de Lorex según esta o cualquier otra garantía, implícita o explícita, está limitada a la reparación, reemplazo o reembolso, como se establece anteriormente. Estas compensaciones son el único y exclusivo remedio por cualquier incumplimiento de garantía. Lorex no es responsable por daños y perjuicios directos, especiales, incidentes o consecuentes resultantes de algún incumplimiento de garantía o bajo cualquier otra teoría legal, incluyendo pero sin estar limitada a: pérdida de utilidades, paralización, plusvalía, daños o reemplazo de equipos y propiedad y cualquier costo de recuperar, reprogramar o reproducir cualquier programa o datos almacenados o usados con un sistema que contenga el CD-ROM del Producto o el software que lo acompaña.

Lorex no garantiza que el software operará con ningún otro software excepto con el que se indica. Lorex no puede ser responsable de las características de hardware o software de terceras personas que puedan atectar la operación del software incluido.

El comprador puede tener otros derechos de acuerdo con las leyes federales, provinciales o estatales y cuando toda esta garantía o parte de la misma sea prohibida por dichas leyes, será considerada nula, pero el resto de la garantía permanecerá vigente.

Todas las garantías expresadas e implícitas están limitadas en duración al período de garantía limitada. Ninguna garantía se aplicará después de dicho período. Algunos estados no permiten limitación a la duración de una garantía implícita, de modo que esta limitación puede no ser de aplicación. Algunos estados no permiten la exclusión o limitación de daños y perjuicios incidentes o consecuentes, por lo que la garantía anterior puede no ser de aplicación. Esta garantía limitada le otorga derechos legales específicos y usted puede también tener otros derechos que varía de un estado a otro.

Cómo obtener servicio

Con el fin de obtener servicio, por favor asegúrese de registrar haber registrado su producto en nuestra página web www.lorexctv.com en la sección de registro de garantía. Si el Producto necesitase servicio bajo esta garantía, el Comprador debe hacer llegar a Lorex una copia del recibo o factura de compra, con su fecha respectiva, sin lo cual Lorex no estará obligada a cumplir con ninguna de sus obligaciones bajo esta garantía. Si devuelve el Producto y/o el CD-ROM a Lorex, debe usted asumir el riesgo de daño o pérdida durante el envío. Debe usar el envase original o equivalente y debe pagar el flete.

Para hacer un reclamo bajo esta garantía, proceda con los siguientes pasos.

1. Empaque el Producto en una caja robusta bien acolchada.
 - i). Si la unidad fue comprada en Estados Unidos proceda en la siguiente forma:
 - a. Para devoluciones por favor contacte nuestro departamento de servicio para obtener un número de autorización
 - b. Devuelva la unidad a:
Lorex Returns
c/o Russell Farrow
15 Lawrence Bell Drive, Amherst, NY 14221
 - ii). Si la unidad fue comprada en Canadá proceda en la siguiente forma:
 - a. Para devoluciones por favor contacte nuestro departamento de servicio para obtener un número de autorización.
 - b. Devuelva la unidad a:
Lorex Customer Service,
250 Royal Crest Court, Markham, Ont. L3R 3S1
 - iii) Si la unidad fue adquirida en Europa y desea devolver el producto por favor visite:
www.lorexinternational.com para obtener instrucciones.

NUMERO GRATUITO DE SERVICIO A CLIENTES:

Norteamérica: 1-888-42-LOREX (1-888-425-6739)

Internacional: 800-42-LOREX 0 (800-425-67390)

Local : 905-940-5355

www.lorexctv.com

Use siempre discreción cuando instale equipo de vigilancia por video y/o audio especialmente cuando se percibe privacidad. Consulte acerca de las regulaciones federales, estatales y/o locales aplicables a la instalación legal de equipos de grabación o vigilancia por video y/o audio. Puede requerirse el consentimiento de las partes.

CONNECT . PROTECT



Enhance your security with genuine Lorex Cameras, Digital Video Recorders, Integrated Systems and Accessories. Order whatever you need at www.lorextechnology.com or call 1-888-42-LOREX (1-888-425-6739)

Warehouse



CVC6998HR

Office



LNZ4001

Restaurant



VQ1536HR

Convenience Store



LW2100

Day Care



LW2702

PROTECT EVERYTHING THAT MATTERS

Add wired or wireless cameras to expand the "Envelope of Protection" for your business, your home and your family

Home Office



LW2002B

Drive Way



SG7540

Front Door



LW2301

Nursery



LW2002W

Backyard



LW2201